

Schüco Designlinie
mit verdeckter Griffbefestigung und flacher Rosette
*Schüco Design line
with handle fixing and flush rosette*



Schüco Designlinie mit verdeckter Griffbefestigung und flacher Rosette

Schüco Design line with handle fixing and flush rosette

Türdrücker für Rohrrahmentüren und Türschlossern mit 10er Nuß

- mit Rückholfeder und verdeckt liegender Befestigung.
- Die eingebaute Rückholfeder sorgt immer für einen waagerechten Sitz.
- Die PZ-Rosette (selbstklebend) und das Befestigungszubehör sind im Lieferumfang enthalten.

Door handles for tubular frame doors and door locks with 10 mm spindle

- With return spring and concealed fixing
- The built-in return spring ensures the handle always maintains a horizontal position.
- The profile cylinder rosette (self-adhesive) and fixing accessories are included.

gerade Ausführung, ovale Rosette, Drückerstift □ 10 mm GRUPPE 3



Straight design, oval rosette Spindle □ 10 mm GROUP 3

Material Material	Farbe Colour		Hinweis Note	
Alu	C0	240 208	-	1
Alu	RAL 9005	240 218	①	1
Alu	RAL 9010	240 219	①	1
Alu	RAL 9016	240 220	①	1
INOX	-	240 212	-	1

① über Sonderbestellung lieferbar
Available to special order

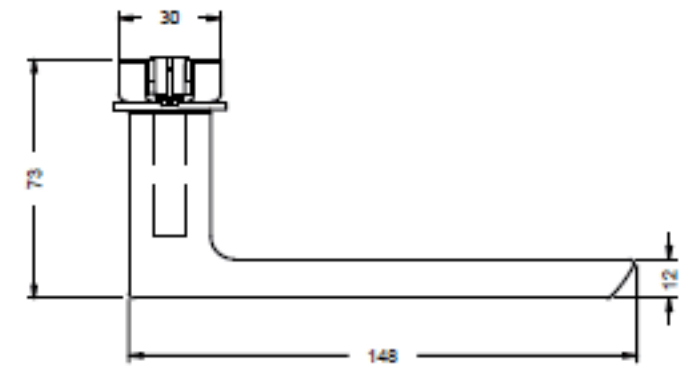

gerade Ausführung, ovale Langschild-Rosette, Drückerstift □ 10 mm GRUPPE 3

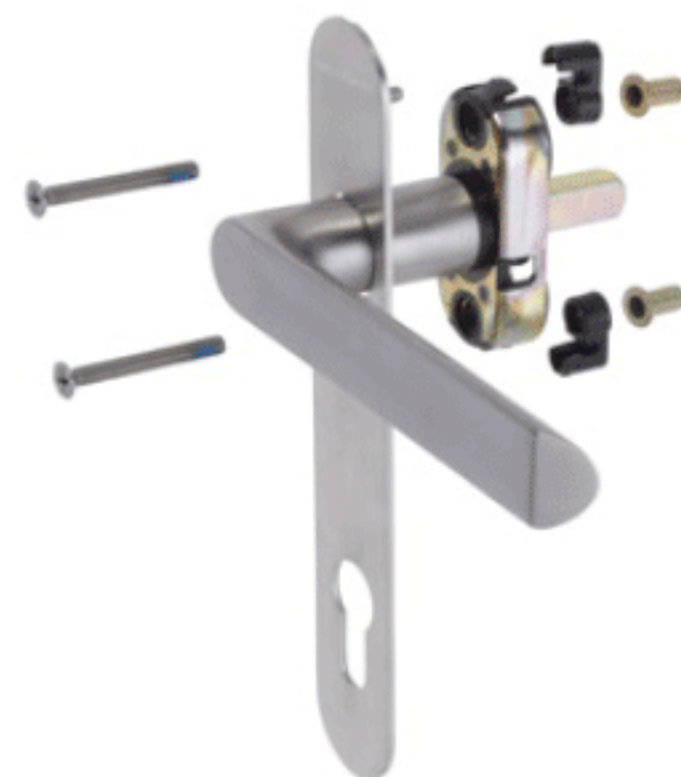

Straight design, oval long plate rosette Spindle □ 10 mm GROUP 3

Material Material	Farbe Colour		Hinweis Note	
Alu	C0	240 230	-	1
Alu	RAL 9005	240 231	①	1
Alu	RAL 9010	240 232	①	1
Alu	RAL 9016	240 233	①	1
INOX	-	240 234	-	1

① über Sonderbestellung lieferbar
Available to special order

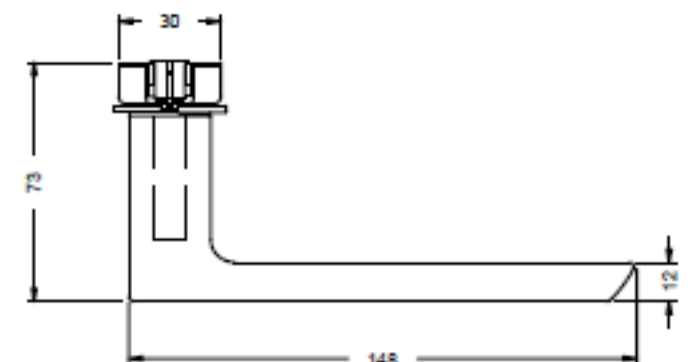

- Nur einsetzbar in Kombination mit speziell gekennzeichneten Schließern.
- Für Konstruktionen mit aufschlagendem Flügel, Distanzstück Art.-Nr. 240 249 gesondert bestellen.
- Only for use in conjunction with special indicated locks.
- For constructions with rebated door leaves, please order spacer Art. No. 240 249 separately.

Schüco Designlinie mit verdeckter Griffbefestigung und flacher Rosette

Schüco Design line with handle fixing and flush rosette

Türdrücker für Rohrrahmentüren und Türschlössern mit 10er Nuß

- mit Rückholfeder und verdeckt liegender Befestigung.
- Die eingebaute Rückholfeder sorgt immer für einen waagerechten Sitz.
- Die PZ-Rosette (selbstklebend) und das Befestigungszubehör sind im Lieferumfang enthalten.

gekröpfte Ausführung, ovale Rosette, Drückerstift □ 10 mm GRUPPE 1 empfohlen von GUVV



Door handles for tubular frame doors and door locks with 10 mm spindle

- With return spring and concealed fixing
- The built-in return spring ensures the handle always maintains a horizontal position.
- The profile cylinder rosette (self-adhesive) and fixing accessories are included.

Cranked design, oval rosette Spindle □ 10 mm GROUP 1 Recommended by GUVV

Material Material	Farbe Colour		Hinweis Note	
Alu	C0	240 209	-	1
Alu	RAL 9005	240 221	①	1
Alu	RAL 9010	240 222	①	1
Alu	RAL 9016	240 223	①	1
INOX	-	240 213	-	1

① über Sonderbestellung lieferbar
Available to special order

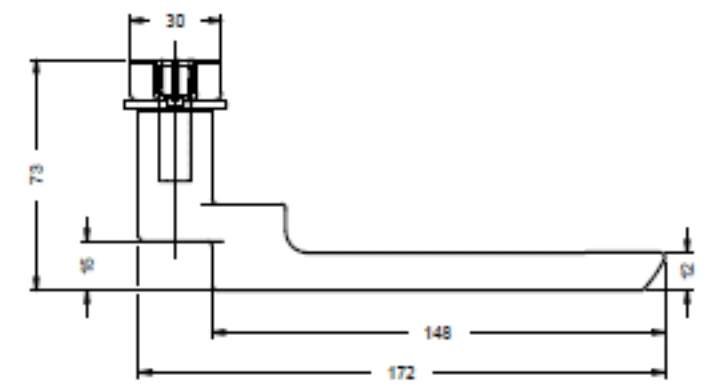

gekröpfte Ausführung, ovale Langschild-Rosette, Drückerstift □ 10 mm GRUPPE 1 empfohlen von GUVV



Cranked design, oval long plate rosette Spindle □ 10 mm GROUP 1 Recommended by GUVV

Material Material	Farbe Colour		Hinweis Note	
Alu	C0	240 235	-	1
Alu	RAL 9005	240 236	①	1
Alu	RAL 9010	240 237	①	1
Alu	RAL 9016	240 238	①	1
INOX	-	240 239	-	1

① über Sonderbestellung lieferbar
Available to special order

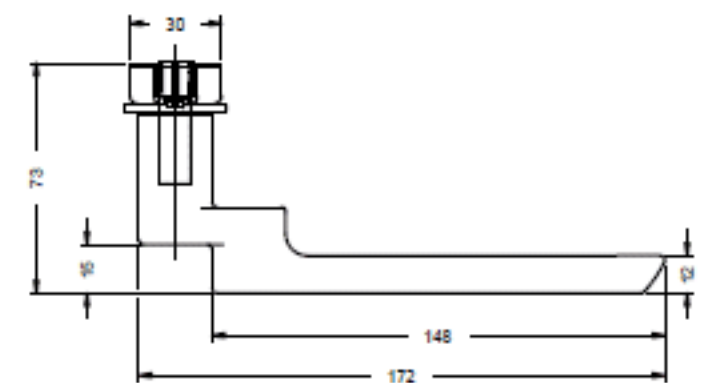

- Nur einsetzbar in Kombination mit speziell gekennzeichneten Schlössern.
- Für Konstruktionen mit aufschlagendem Flügel, Distanzstück Art.-Nr. 240 249 gesondert bestellen.
- Für Konstruktionen mit Mehrfachverriegelungen, Stützplatte Art.-Nr. 240 248 gesondert bestellen.
- Only for use in conjunction with special indicated locks.
- For constructions with multi-point locking, please order support plate Art. No. 240 248 separately.
- For constructions with flush-fitted vents, please order support plate Art. No. 240 249 separately.

Schüco Designlinie
Schüco feature range

**Türdrücker für Rohrrahmentüren
und Türschlossern mit 10er Nuß**





**Door handles for tubular frame doors
and door locks with 10 mm spindle**

- mit Rückholfeder und verdeckt liegender Befestigung.
- Die eingebaute Rückholfeder sorgt immer für einen waagerechten Sitz.

- With return spring and concealed fixing
- The built-in return spring ensures the handle always maintains a horizontal position.

gerade Ausführung, ovale Rosette,
Drückerstift □ 10 mm GRUPPE 3





*Straight design, oval rosette
Spindle □ 10 mm GROUP 3*

Material Material	Farbe Colour		Hinweis Note			Hinweis Note	
Alu	C0	240 152	-	10	218 893	-	10
Alu	RAL 9005	240 153	-	10	227 652	-	10
Alu	RAL 9010	240 154	-	10	218 895	-	10
Alu	RAL 9016	240 155	-	10	218 896	-	10
INOX	-	240 168	-	1	218 897	-	1

Drückerstift, Befestigungsplatte und Befestigungsschrauben gesondert bestellen.
Please order spindle, fixing plate and fixing screws separately.

gekröpfte Ausführung, ovale Rosette,
Drückerstift □ 10 mm GRUPPE 1
empfohlen von GUVV

*Cranked design, oval rosette
Spindle □ 10 mm GROUP 1
Recommended by GUVV*

Material Material	Farbe Colour		Hinweis Note			Hinweis Note	
Alu	C0	240 156	-	10	218 893	-	10
Alu	RAL 9005	240 157	-	10	227 652	-	10
Alu	RAL 9010	240 158	-	10	218 895	-	10
Alu	RAL 9016	240 159	-	10	218 896	-	10
INOX		240 169	-	1	218 897	-	1

Drückerstift, Befestigungsplatte und Befestigungsschrauben gesondert bestellen.
Please order spindle, fixing plate and fixing screws separately.

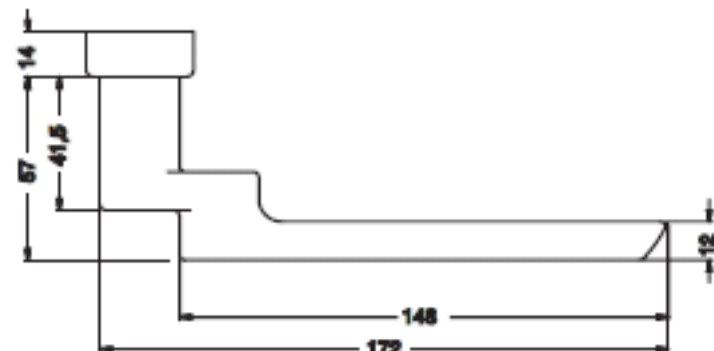
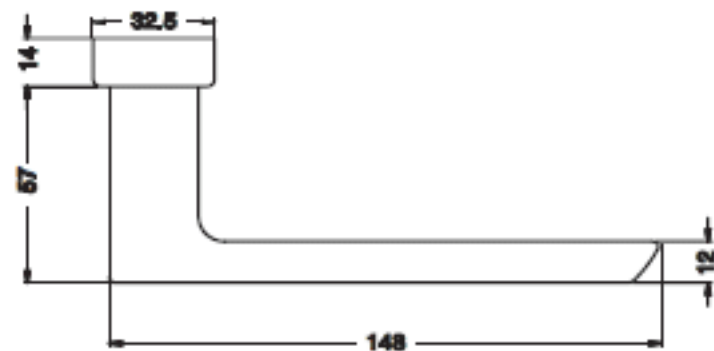

Schüco Designlinie
Schüco feature range

Türdrücker für Antipanikschlösser mit 9er Nuß (Ausführung ist nicht für Rauchschutztüren zugelassen)

Door handles for panic locks with 9 mm spindle (design not approved for smoke doors)

- mit Rückholfeder und verdeckt liegender Befestigung.
- Die eingebaute Rückholfeder sorgt immer für einen waagerechten Sitz.

- With return spring and concealed fixing
- The built-in return spring ensures the handle always maintains a horizontal position.

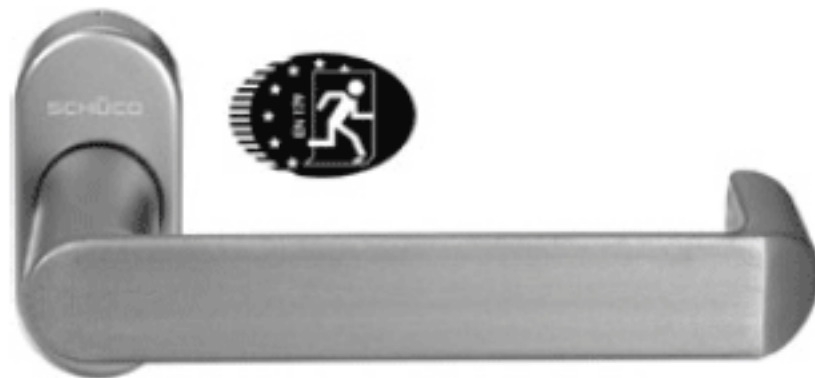

gerade Ausführung, ovale Rosette, Drückerstift □ 9 mm

Straight design, oval rosette, spindle □ 9 mm

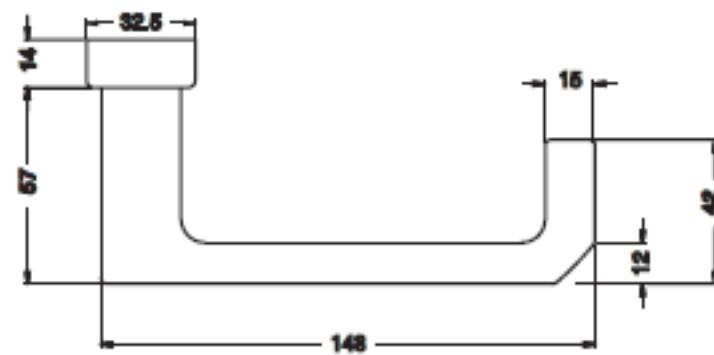

Material	Farbe		Hinweis			Hinweis	
Material	Colour		Note			Note	
Alu	C0	240 160	-	10	218 893	-	10
Alu	RAL 9005	240 161	-	10	227 652	-	10
Alu	RAL 9010	240 162	-	10	218 895	-	10
Alu	RAL 9016	240 163	-	10	218 896	-	10
INOX	-	240 186	-	1	218 897	-	1

Drückerstift, Befestigungsplatte und Befestigungsschrauben gesondert bestellen.
Please order spindle, fixing plate and fixing screws separately.

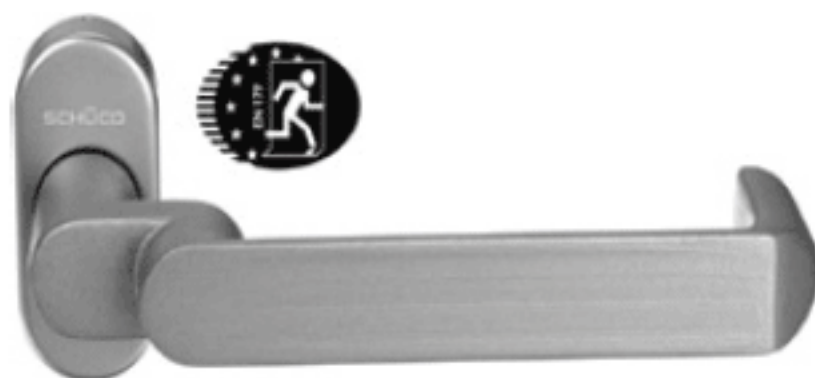

gekröpfte Ausführung, ovale Rosette, Drückerstift □ 9 mm
empfohlen von GUVV

Cranked design, oval rosette, spindle □ 9 mm
Recommended by GUVV

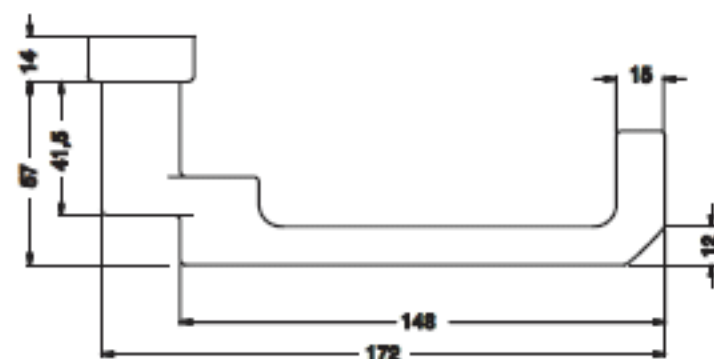

Material	Farbe		Hinweis			Hinweis	
Material	Colour		Note			Note	
Alu	C0	240 164	-	10	218 893	-	10
Alu	RAL 9005	240 165	-	10	227 652	-	10
Alu	RAL 9010	240 166	-	10	218 895	-	10
Alu	RAL 9016	240 167	-	10	218 896	-	10
INOX	-	240 191	-	1	218 897	-	1

Drückerstift, Befestigungsplatte und Befestigungsschrauben gesondert bestellen.
Please order spindle, fixing plate and fixing screws separately.

Schüco Designlinie
Schüco feature range

Türdrücker für Umlenkgetriebe mit 9er Nuss und Rückholfeder, gemäß DIN 18273



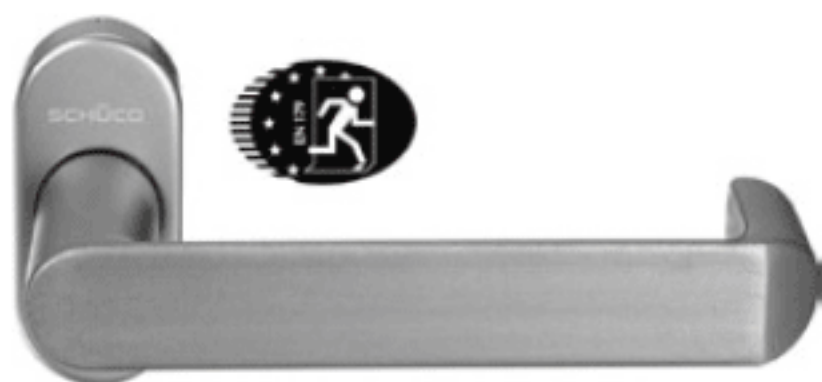

- verdecktliegende Befestigung
- Drückernuss: □ 9 mm

Handles for panic locks with 9 mm spindle and return spring, conforming to DIN 18273

- Concealed fixing
- Spindle: □ 9 mm



gerade Ausführung, ovale Rosette
Straight design, oval rosette, spindle □ 9 mm

Material Material	Farbe Colour		Hinweis Note			Hinweis Note	
Alu	CO	240 182	-	1	218 893	-	10
Alu	RAL 9005	240 183	-	1	227 652	-	10
Alu	RAL 9010	240 184	-	1	218 895	-	10
Alu	RAL 9016	240 185	-	1	218 896	-	10
INOX	-	240 186	-	1	218 897	-	1

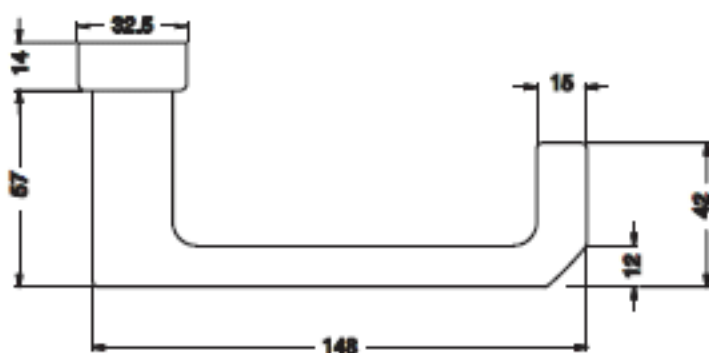

Bei Einsatz in Verbindung mit Umlenkgetriebe muss die Rückholfeder im Türdrücker entfernt werden.

When used in conjunction with a shoot bolt return mechanism, the return spring in the door handle must be removed.

FSB Design 1076

Türdrücker für Rohrrahmentüren und Türschlossern mit 10er Nuß

- mit Rückholfeder
- mit verdeckt liegender Befestigung

Door handles for tubular frame doors and door locks with 10 mm spindle

- With return spring
- With concealed fixings

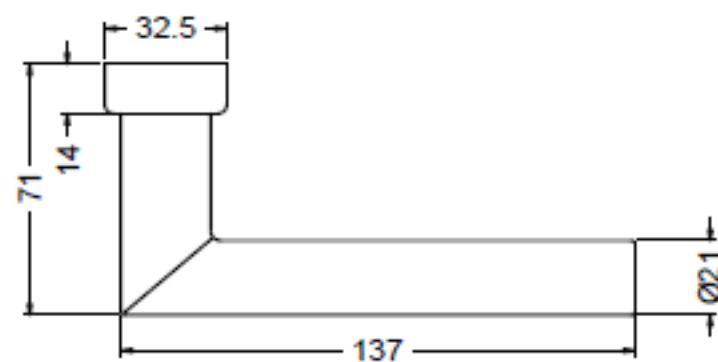

gerade Ausführung, ovale Rosette,
Drückerstift □ 10 mm GRUPPE 3
Straight design, oval rosette
Spindle □ 10 mm GROUP 3

Material	Farbe		Hinweis		Hinweis		
Material	Colour		Note		Note		
Alu	C0	240 032	-	10	218 893	-	10
INOX		240 037	-	1	218 897	-	1

Drückerstift (□ 10mm), PZ-Rosette und Befestigungsschrauben gesondert bestellen.
Order spindle (□ 10mm), expansion anchor 205 980, PC rosette and fixing screws separately.

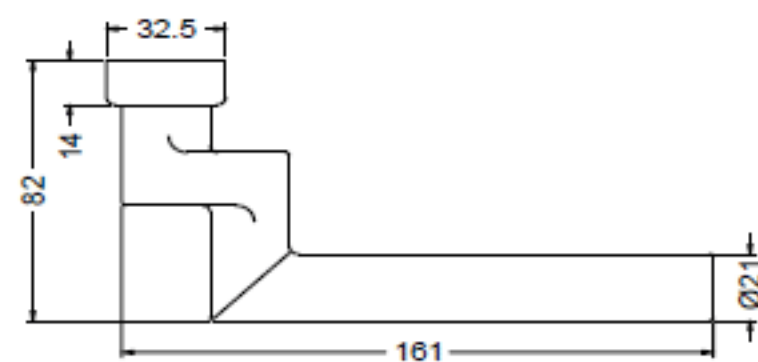

gekröpfte Ausführung, ovale Rosette,
Drückerstift □ 10 mm GRUPPE 1
empfohlen von GUVV
Cranked design, oval rosette
Spindle □ 10 mm GROUP 1
Recommended by GUVV

Material	Farbe		Hinweis		Hinweis		
Material	Colour		Note		Note		
Alu	C0	240 033	-	10	218 893	-	10
INOX		240 038	-	1	218 897	-	1

Als Sonderbestellung erhältliche Gamituren für Vollblattdüren
Designs for full-leaf doors available to special order

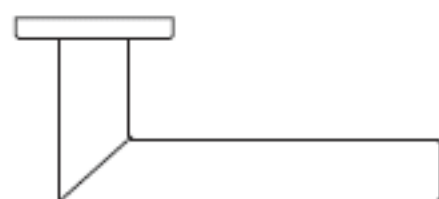
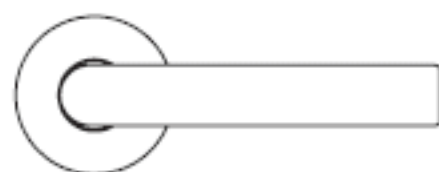

Ausführung auf runder Rosette, Drückerstift □ 8 mm
Version with round rosette, spindle □ 8 mm

Material	Farbe		Hinweis		Hinweis		
Material	Colour		Note		Note		
Alu	C0	240 029	-	2	●	-	2
INOX		240 034	-	2	●	-	2

Drückerstift (□ 8mm), PZ-Rosette (Ø 55mm) bzw. Kurzschild und Befestigungsschrauben sind im Lieferumfang enthalten.
Spindle (□ 8mm), profile cylinder rosette (Ø 55mm) or plate and fixing screws are contained in the pack.

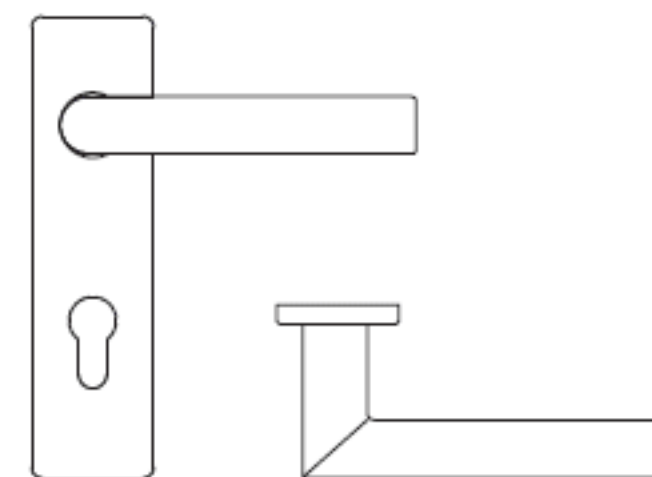

Ausführung auf eckigem Kurzschild, Drückerstift □ 8 mm
Version with square plate, spindle □ 8 mm

Material	Farbe		Hinweis		Hinweis		
Material	Colour		Note		Note		
Alu	C0	240 030	-	2	●	-	2
INOX		240 035	-	2	●	-	2

FSB Design 1016

Türdrücker für Rohrrahmentüren und Türschlössern mit 10er Nuß

- mit Rückholfeder
- mit verdeckt liegender Befestigung

Door handles for tubular frame doors and door locks with 10 mm spindle

- With return spring
- With concealed fixings

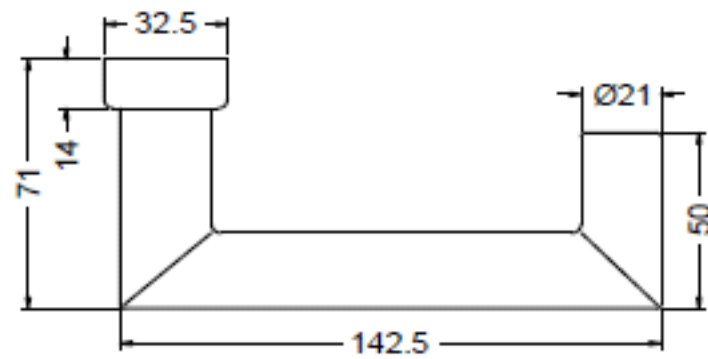
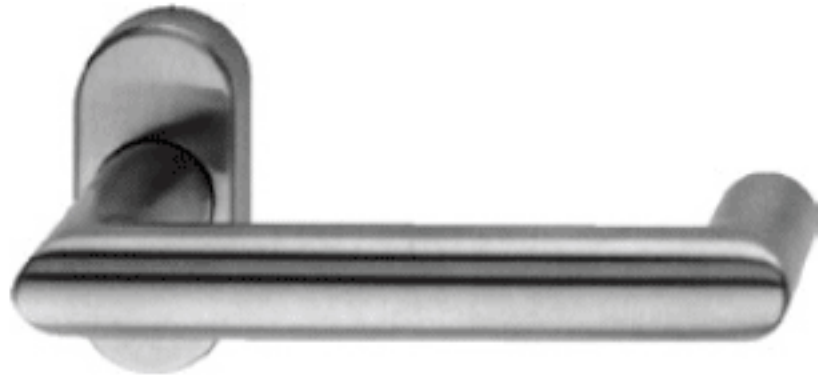

gerade Ausführung, ovale Rosette,
Drückerstift □ 10 mm GRUPPE 3
Straight design, oval rosette
Spindle □ 10 mm GROUP 3

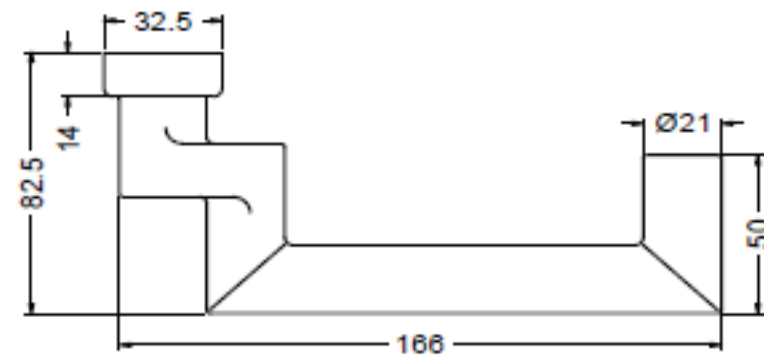

gekröpfte Ausführung, ovale Rosette,
Drückerstift □ 10 mm GRUPPE 1
empfohlen von GUVV
Cranked design, oval rosette
Spindle □ 10 mm GROUP 1
Recommended by GUVV

Material	Farbe		Hinweis		Hinweis	
Material	Colour		Note		Note	
Alu	C0	240 004	-	10	218 893	-
INOX		240 009	-	1	218 897	-

Material	Farbe		Hinweis		Hinweis	
Material	Colour		Note		Note	
Alu	C0	240 005	-	10	218 893	-
INOX		240 010	-	1	218 897	-

Drückerstift (□ 10mm), PZ-Rosette und Befestigungsschrauben gesondert bestellen.
Order spindle (□ 10mm), expansion anchor 205 980, PC rosette and fixing screws separately.

Als Sonderbestellung erhältliche Gamituren für Vollblattdüren
Designs for full-leaf doors available to special order

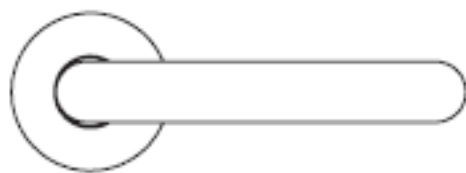

Ausführung auf runder Rosette, Drückerstift □ 8 mm
Version with round rosette, spindle □ 8 mm

Material	Farbe		Hinweis		Hinweis	
Material	Colour		Note		Note	
Alu	C0	240 001	-	2	●	-
INOX		240 006	-	2	●	-

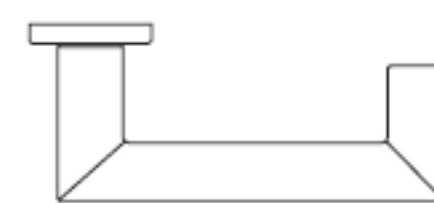
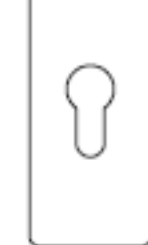

Ausführung auf eckigem Kurzchild, Drückerstift □ 8 mm
Version with square plate, spindle □ 8 mm

Material	Farbe		Hinweis		Hinweis	
Material	Colour		Note		Note	
Alu	C0	240 002	-	2	●	-
INOX		240 007	-	2	●	-

Drückerstift (□ 8 mm), PZ-Rosette (Ø 55 mm) bzw. Kurzchild und Befestigungsschrauben sind im Lieferumfang enthalten.
Spindle (□ 8 mm), profile cylinder rosette (Ø 55 mm) or plate and fixing screws are contained in the pack.

FSB Design 1075

Türdrücker für Rohrrahmentüren und Türschlossern mit 10er Nuß

- mit Rückholfeder
- mit verdeckt liegender Befestigung

Door handles for tubular frame doors and door locks with 10 mm spindle

- With return spring
- With concealed fixings

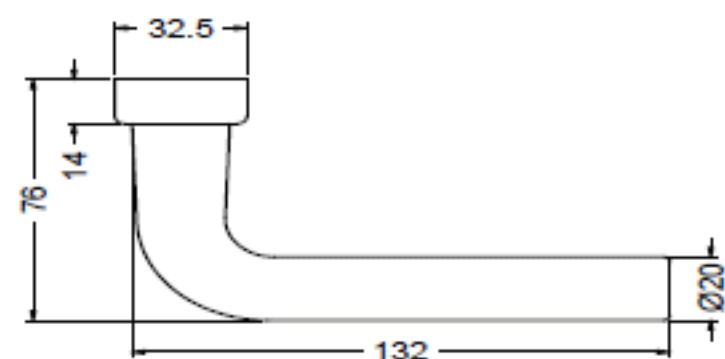

Ausführung gerade, ovale Rosette,
Drückerstift □ 10 mm GRUPPE 3
Straight design, oval rosette,
Spindle □ 10 mm GROUP 3

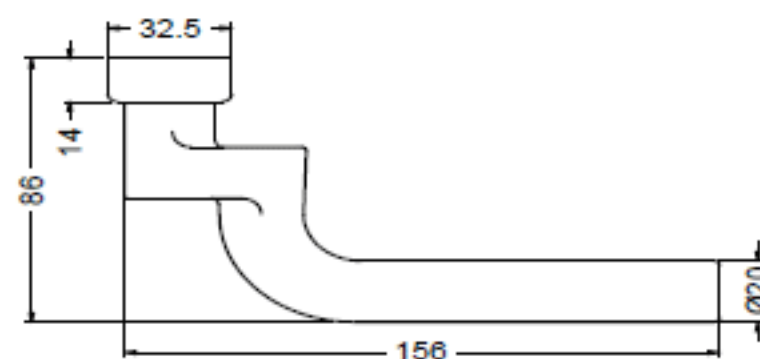

gekröpfte Ausführung, ovale Rosette,
Drückerstift □ 10 mm GRUPPE 1
empfohlen von GUVV
Cranked design, oval rosette
Spindle □ 10 mm GROUP 1
Recommended by GUVV

Material	Farbe		Hinweis		Hinweis		
Material	Colour		Note		Note		
Alu	C0	240 022	-	10	218 893	-	10
INOX		240 027	-	1	218 897	-	1

Material	Farbe		Hinweis		Hinweis		
Material	Colour		Note		Note		
Alu	C0	240 023	-	10	218 893	-	10
INOX		240 028	-	1	218 897	-	1

Drückerstift (□ 10mm), PZ-Rosette und Befestigungsschrauben gesondert bestellen.
Order spindle (□ 10mm), expansion anchor 205 980, PC rosette and fixing screws separately.

Als Sonderbestellung erhältliche Gamituren für Vollblättüren
Designs for full-leaf doors available to special order

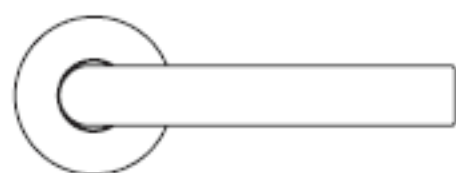

Ausführung auf runder Rosette, Drückerstift □ 8 mm
Version with round rosette, spindle □ 8 mm

Material	Farbe		Hinweis		Hinweis		
Material	Colour		Note		Note		
Alu	C0	240 019	-	2	●	-	2
INOX		240 024	-	2	●	-	2

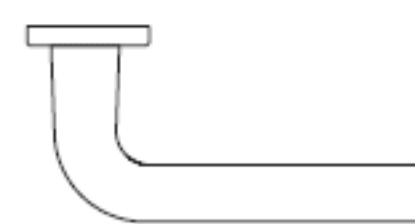
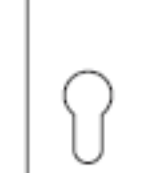

Ausführung auf abgerundeten Kurzschild, Drückerstift □ 8 mm
Version with rounded plate, spindle □ 8 mm

Material	Farbe		Hinweis		Hinweis		
Material	Colour		Note		Note		
Alu	C0	240 021	-	2	●	-	2
INOX		240 026	-	2	●	-	2

Drückerstift (□ 8 mm), PZ-Rosette (Ø 55 mm) bzw. Kurzschild und Befestigungsschrauben sind im Lieferumfang enthalten.
Spindle (□ 8 mm), profile cylinder rosette (Ø 55 mm) or plate and fixing screws are contained in the pack.

FSB Design 1070

Türdrücker für Rohrrahmentüren und Türschlösser mit 10er Nuß

- mit Rückholfeder
- mit verdeckt liegender Befestigung

Door handles for tubular frame doors and door locks with 10 mm spindle

- With return spring
- With concealed fixings

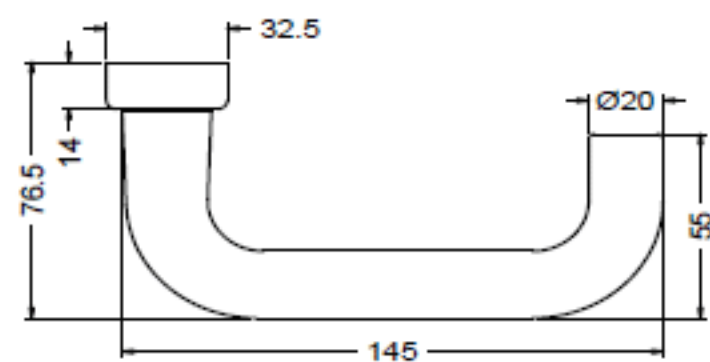
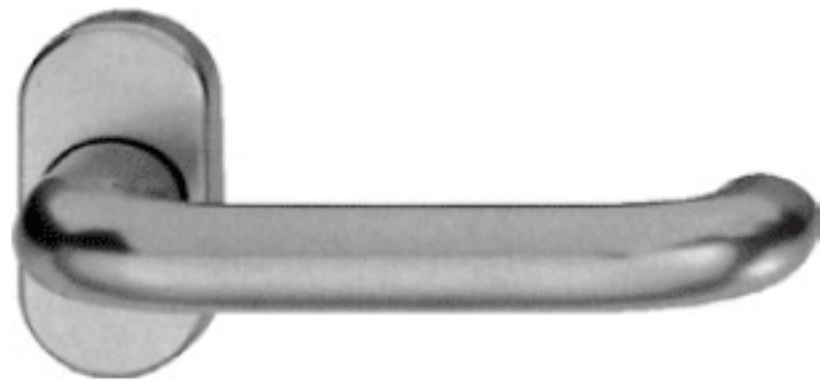

gerade Ausführung, ovale Rosette,
Drückerstift □ 10 mm GRUPPE 3
Straight design, oval rosette
Spindle □ 10 mm GROUP 3

Material	Farbe		Hinweis		Hinweis	
Material	Colour		Note		Note	
Alu	C0	240 071	-	10	218 893	-
INOX		210 713	-	1	218 897	-

Drückerstift (□ 10mm), PZ-Rosette und Befestigungsschrauben gesondert bestellen.
Order spindle (□ 10mm), expansion anchor 205 980, PC rosette and fixing screws separately.

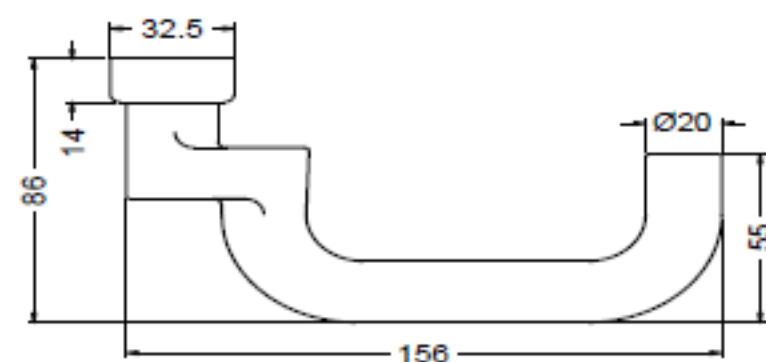

Ausführung gekröpft, ovale Rosette,
Drückerstift □ 10 mm GRUPPE 1
empfohlen von GUVV
Straight design, oval rosette,
Spindle □ 10 mm GROUP 1
Recommended by GUVV

Material	Farbe		Hinweis		Hinweis	
Material	Colour		Note		Note	
Alu	C0	240 014	-	10	218 893	-
INOX		240 018	-	1	218 897	-

Als Sonderbestellung erhältliche Gamituren für Vollblättüren
Designs for full-leaf doors available to special order

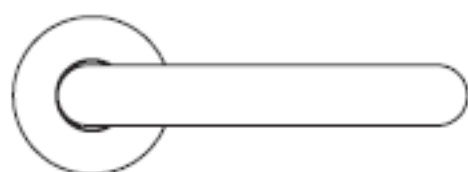

Ausführung auf runder Rosette, Drückerstift □ 8 mm
Version with round rosette, spindle □ 8 mm

Material	Farbe		Hinweis		Hinweis	
Material	Colour		Note		Note	
Alu	C0	240 011	-	2	●	-
INOX		240 015	-	2	●	-

Drückerstift (□ 8 mm), PZ-Rosette (Ø 55 mm) bzw. Kurzschild und Befestigungsschrauben sind im Lieferumfang enthalten.
Spindle (□ 8 mm), profile cylinder rosette (Ø 55 mm) or plate and fixing screws are contained in the pack.

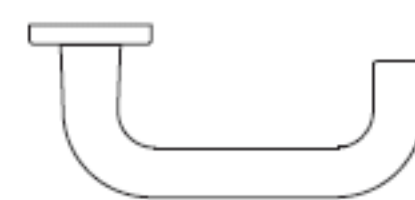

Ausführung auf abgerundeten Kurzschild, Drückerstift □ 8 mm
Version with rounded plate, spindle □ 8 mm

Material	Farbe		Hinweis		Hinweis	
Material	Colour		Note		Note	
Alu	C0	240 013	-	2	●	-
INOX		240 017	-	2	●	-

FSB Design 1107

Türdrücker für Rohrrahmentüren und Türschlossern mit 10er Nuß

- mit Rückholfeder
- mit verdeckt liegender Befestigung

Door handles for tubular frame doors and door locks with 10 mm spindle

- With return spring
- With concealed fixings

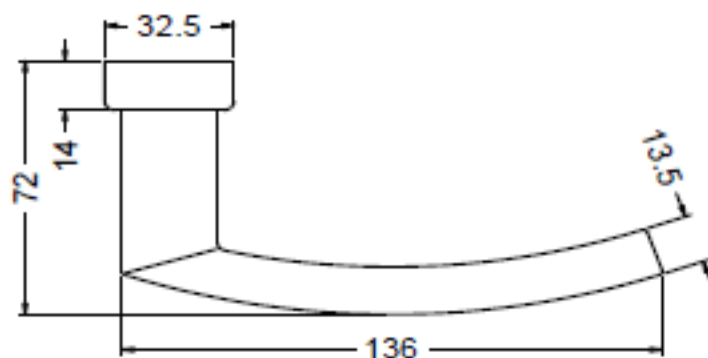

gerade Ausführung, ovale Rosette,
Drückerstift □ 10 mm GRUPPE 3
Straight design, oval rosette
Spindle □ 10 mm GROUP 3

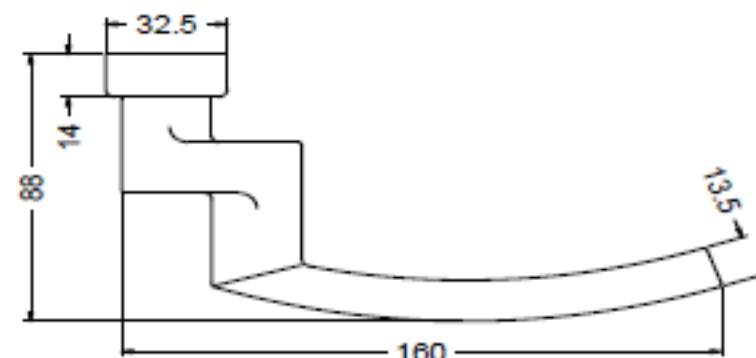

Ausführung gekröpft, ovale Rosette,
Drückerstift □ 10 mm GRUPPE 1
empfohlen von GUVV
Straight design, oval rosette,
Spindle □ 10 mm GROUP 1
Recommended by GUVV

Material	Farbe		Hinweis		Hinweis	
Material	Colour		Note		Note	
Alu	C0	240 042	-	10	218 893	-
INOX		240 047	-	1	218 897	-

Material	Farbe		Hinweis		Hinweis	
Material	Colour		Note		Note	
Alu	C0	240 043	①	10	218 893	-
INOX		240 048	-	1	218 897	-

Drückerstift (□ 10mm), PZ-Rosette und Befestigungsschrauben gesondert bestellen.
Order spindle (□ 10mm), expansion anchor 205 980, PC rosette and fixing screws separately.

① über Sonderbestellung lieferbar
Available to special order

Als Sonderbestellung erhältliche Gamituren für Vollblattdüren
Designs for full-leaf doors available to special order

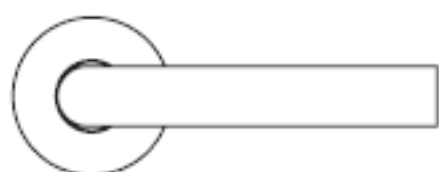

Ausführung auf runder Rosette, Drückerstift □ 8 mm
Version with round rosette, spindle □ 8 mm

Material	Farbe		Hinweis		Hinweis	
Material	Colour		Note		Note	
Alu	C0	240 039	-	2	●	-
INOX		240 044	-	2	●	-



Ausführung auf abgerundeten Kurzschild, Drückerstift □ 8 mm
Version with rounded plate, spindle □ 8 mm

Material	Farbe		Hinweis		Hinweis	
Material	Colour		Note		Note	
Alu	C0	240 041	-	2	●	-
INOX		240 046	-	2	●	-

Drückerstift (□ 8 mm), PZ-Rosette (Ø 55 mm) bzw. Kurzschild und Befestigungsschrauben sind im Lieferumfang enthalten.
Spindle (□ 8 mm), profile cylinder rosette (Ø 55 mm) or plate and fixing screws are contained in the pack.

FSB Design 1177

Türdrücker für Rohrrahmentüren und Türschlössern mit 10er Nuß

- mit Rückholfeder
- mit verdeckt liegender Befestigung

Door handles for tubular frame doors and door locks with 10 mm spindle

- With return spring
- With concealed fixings

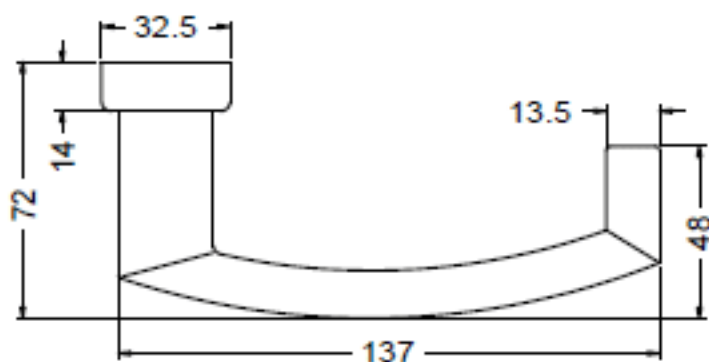

gerade Ausführung, ovale Rosette,
Drückerstift □ 10 mm GRUPPE 3
Straight design, oval rosette
Spindle □ 10 mm GROUP 3

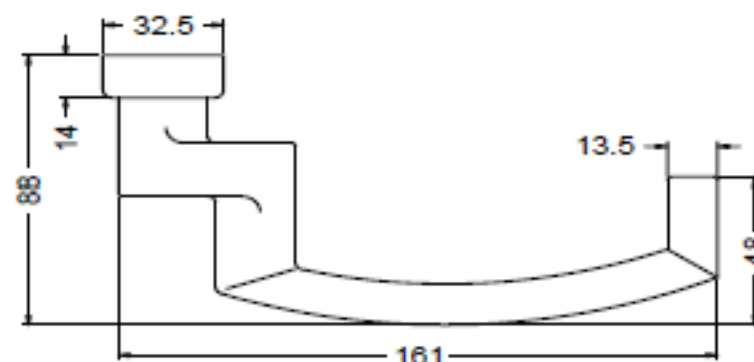

Ausführung gekröpft, ovale Rosette,
Drückerstift □ 10 mm GRUPPE 1
empfohlen von GUVV
Straight design, oval rosette,
Spindle □ 10 mm GROUP 1
Recommended by GUVV

Material	Farbe		Hinweis			Hinweis	
Material	Colour		Note			Note	
Alu	C0	240 075	①	10	218 893	-	10
INOX		240 080	-	1	218 897	-	1

Material	Farbe		Hinweis			Hinweis	
Material	Colour		Note			Note	
Alu	C0	240 076	①	10	218 893	-	10
INOX		240 081	-	1	218 897	-	1

Drückerstift (□ 10mm), PZ-Rosette und Befestigungsschrauben gesondert bestellen.
Order spindle (□ 10mm), expansion anchor 205 980, PC rosette and fixing screws separately.

① über Sonderbestellung lieferbar
Available to special order

Als Sonderbestellung erhältliche Gamituren für Vollblättüren
Designs for full-leaf doors available to special order

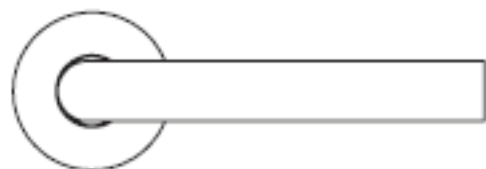

Ausführung auf runder Rosette, Drückerstift □ 8 mm
Version with round rosette, spindle □ 8 mm

Material	Farbe		Hinweis			Hinweis	
Material	Colour		Note			Note	
Alu	C0	240 072	-	2	●	-	2
INOX		240 077	-	2	●	-	2

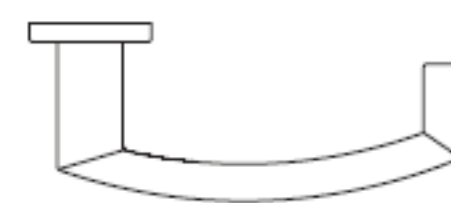
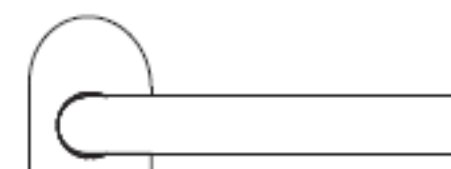

Ausführung auf abgerundeten Kurzschild, Drückerstift □ 8 mm
Version with rounded plate, spindle □ 8 mm

Material	Farbe		Hinweis			Hinweis	
Material	Colour		Note			Note	
Alu	C0	240 074	-	2	●	-	2
INOX		240 079	-	2	●	-	2

Drückerstift (□ 8 mm), PZ-Rosette (Ø 55 mm) bzw. Kurzschild und Befestigungsschrauben sind im Lieferumfang enthalten.
Spindle (□ 8 mm), profile cylinder rosette (Ø 55 mm) or plate and fixing screws are contained in the pack.

FSB Design 1179

Türdrücker für Rohrrahmentüren und Türschlossern mit 10er Nuß

- mit Rückholfeder
- mit verdeckt liegender Befestigung

Door handles for tubular frame doors and door locks with 10 mm spindle

- With return spring
- With concealed fixings

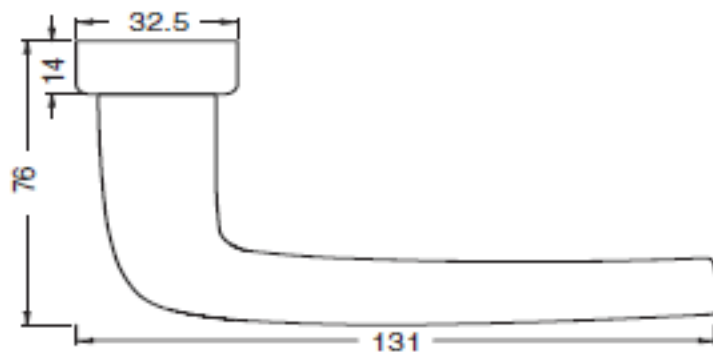

gerade Ausführung, ovale Rosette,
Drückerstift □ 10 mm GRUPPE 3
Straight design, oval rosette
Spindle □ 10 mm GROUP 3



Ausführung gekröpft, ovale Rosette,
Drückerstift □ 10 mm GRUPPE 2
empfohlen von GUVV
Straight design, oval rosette,
Spindle □ 10 mm GROUP 2
Recommended by GUVV

Material	Farbe		Hinweis		Hinweis	
Material	Colour		Note		Note	
Alu	aluminium-grau	240 083	1	238 469	1	10

Material	Farbe		Hinweis		Hinweis	
Material	Colour		Note		Note	
Alu	aluminium-grau	240 084	1	238 469	1	10

Drückerstift (□ 10mm), PZ-Rosette und Befestigungsschrauben gesondert bestellen.
Order spindle (□ 10mm), expansion anchor 205 980, PC rosette and fixing screws separately.

1 über Sonderbestellung lieferbar
Available to special order

Als Sonderbestellung erhältliche Gamituren für Vollblattdüren
Designs for full-leaf doors available to special order



Ausführung auf runder Rosette, Drückerstift □ 8 mm
Version with round rosette, spindle □ 8 mm

Material	Farbe		Hinweis		Hinweis	
Material	Colour		Note		Note	
Alu	aluminium-grau	240 082	-	2	-	2

Drückerstift (□ 8 mm), PZ-Rosette (Ø 55 mm) bzw. Kurzschild und Befestigungsschrauben sind im Lieferumfang enthalten.
Spindle (□ 8 mm), profile cylinder rosette (Ø 55 mm) or plate and fixing screws are contained in the pack.

FSB Design 1078

Türdrücker für Rohrrahmentüren und Türschlossern mit 10er Nuß

- mit Rückholfeder
- mit verdeckt liegender Befestigung

Door handles for tubular frame doors and door locks with 10 mm spindle

- With return spring
- With concealed fixings

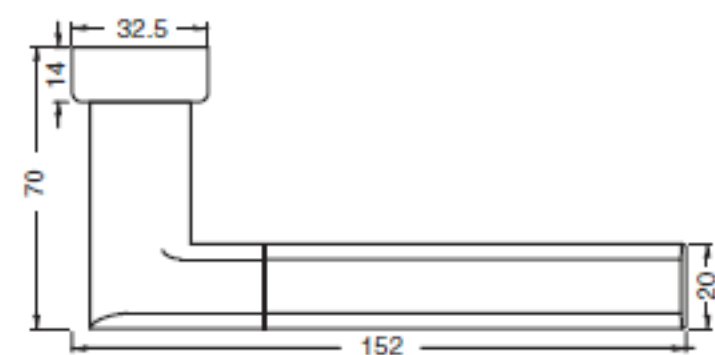

gerade Ausführung, ovale Rosette,
Drückerstift \square 10 mm GRUPPE 3
Straight design, oval rosette
Spindle \square 10 mm GROUP 3

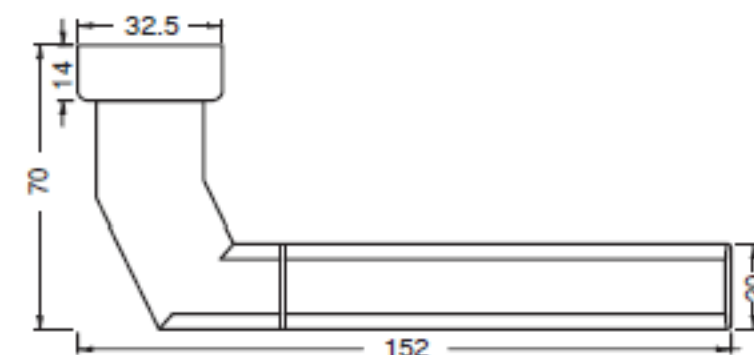

Ausführung gekröpft, ovale Rosette, Drückerstift \square 10 mm
GRUPPE 2 empfohlen von GUVV
Straight design, oval rosette, Spindle \square 10 mm GROUP 2
Recommended by GUVV

Material	Farbe		Hinweis			Hinweis	
Material	Colour		Note			Note	
Alu	aluminium-grau	240 086	①	1	238 469	①	10

Material	Farbe		Hinweis			Hinweis	
Material	Colour		Note			Note	
Alu	aluminium-grau	240 087	①	1	238 469	①	10

Drückerstift (\square 10mm), PZ-Rosette und Befestigungsschrauben gesondert bestellen.
Order spindle (\square 10mm), expansion anchor 205 980, PC rosette and fixing screws separately.

① über Sonderbestellung lieferbar
Available to special order

Als Sonderbestellung erhältliche Gamituren für Vollblättüren
Designs for full-leaf doors available to special order



Ausführung auf runder Rosette, Drückerstift \square 8 mm
Version with round rosette, spindle \square 8 mm

Material	Farbe		Hinweis			Hinweis	
Material	Colour		Note			Note	
Alu	aluminium-grau	240 085	-	2	●	-	2

Drückerstift (\square 8 mm), PZ-Rosette (\varnothing 55 mm) bzw. Kurzschild und Befestigungsschrauben sind im Lieferumfang enthalten.
Spindle (\square 8 mm), profile cylinder rosette (\varnothing 55 mm) or plate and fixing screws are contained in the pack.

FSB Design 1088

Türdrücker für Rohrrahmen Türen und Türschlossern mit 10er Nuß

- mit Rückholfeder
- mit verdeckt liegender Befestigung

Door handles for tubular frame doors and door locks with 10 mm spindle

- With return spring
- With concealed fixings

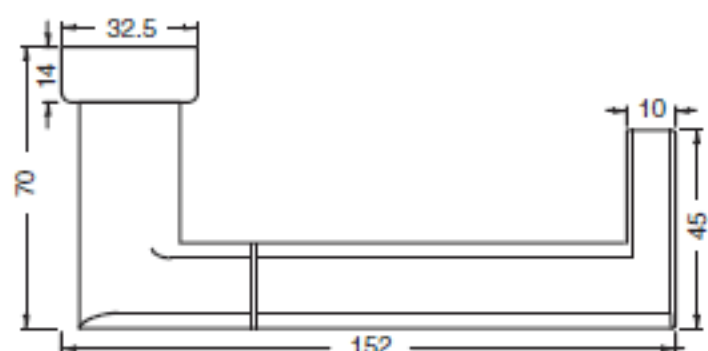

gerade Ausführung, ovale Rosette,
Drückerstift □ 10 mm GRUPPE 3
Straight design, oval rosette
Spindle □ 10 mm GROUP 3

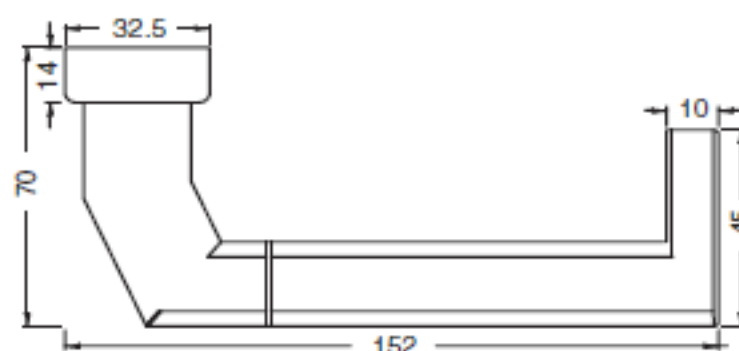

Ausführung gekröpft, ovale Rosette,
Drückerstift □ 10 mm GRUPPE 2
empfohlen von GUVV
Straight design, oval rosette,
Spindle □ 10 mm GROUP 2
Recommended by GUVV

Material	Farbe		Hinweis			Hinweis	
Material	Colour		Note			Note	
Alu	aluminium-grau	240 089	①	1	238 469	①	10

Material	Farbe		Hinweis			Hinweis	
Material	Colour		Note			Note	
Alu	aluminium-grau	240 090	①	1	238 469	①	10

Drückerstift (□ 10mm), PZ-Rosette und Befestigungsschrauben gesondert bestellen.
Order spindle (□ 10mm), expansion anchor 205 980, PC rosette and fixing screws separately.

① über Sonderbestellung lieferbar
Available to special order

Als Sonderbestellung erhältliche Gamituren für Vollblättüren
Designs for full-leaf doors available to special order



Ausführung auf runder Rosette, Drückerstift □ 8 mm
Version with round rosette, spindle □ 8 mm

Material	Farbe		Hinweis			Hinweis	
Material	Colour		Note			Note	
Alu	aluminium-grau	240 088	-	2	●	-	2

Drückerstift (□ 8 mm), PZ-Rosette (Ø 55 mm) bzw. Kurzschild und Befestigungsschrauben sind im Lieferumfang enthalten.
Spindle (□ 8 mm), profile cylinder rosette (Ø 55 mm) or plate and fixing screws are contained in the pack.

FSB Design 1144

Türdrücker für Rohrrahmentüren und Türschlossern mit 10er Nuß

- mit Rückholfeder
- mit verdeckt liegender Befestigung

Door handles for tubular frame doors and door locks with 10 mm spindle

- With return spring
- With concealed fixings

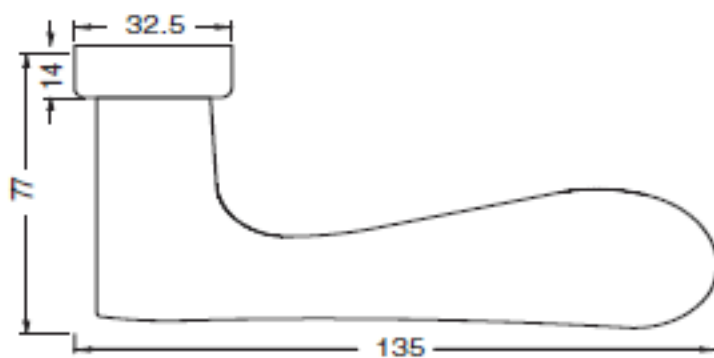

gerade Ausführung, ovale Rosette,
Drückerstift □ 10 mm GRUPPE 3
Straight design, oval rosette
Spindle □ 10 mm GROUP 3

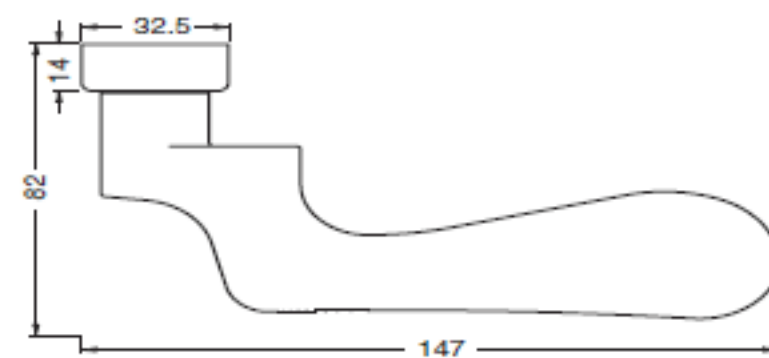
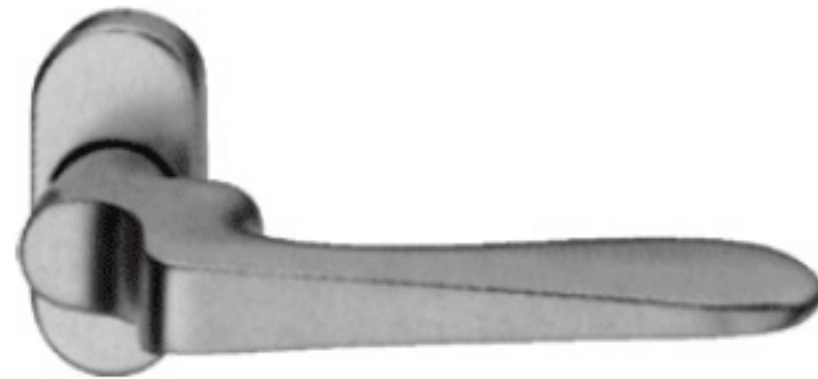

Ausführung gekröpft, ovale Rosette,
Drückerstift □ 10 mm GRUPPE 2
empfohlen von GUVV
Straight design, oval rosette,
Spindle □ 10 mm GROUP 2
Recommended by GUVV

Material	Farbe		Hinweis		Hinweis	
Material	Colour		Note		Note	
Alu	aluminium-grau	240 092	①	1	238 469	① 10

Material	Farbe		Hinweis		Hinweis	
Material	Colour		Note		Note	
Alu	aluminium-grau	240 093	①	1	238 469	① 10

Drückerstift (□ 10mm), PZ-Rosette und Befestigungsschrauben gesondert bestellen.
Order spindle (□ 10mm), expansion anchor 205 980, PC rosette and fixing screws separately.

① über Sonderbestellung lieferbar
Available to special order

Als Sonderbestellung erhältliche Gamituren für Vollblattdüren
Designs for full-leaf doors available to special order



Ausführung auf runder Rosette, Drückerstift □ 8 mm
Version with round rosette, spindle □ 8 mm

Material	Farbe		Hinweis		Hinweis	
Material	Colour		Note		Note	
Alu	aluminium-grau	240 091	-	2	•	- 2

Drückerstift (□ 8 mm), PZ-Rosette (Ø 55 mm) bzw. Kurzschild und Befestigungsschrauben sind im Lieferumfang enthalten.
Spindle (□ 8 mm), profile cylinder rosette (Ø 55 mm) or plate and fixing screws are contained in the pack.

Türdrücker Door handle

Türdrücker für Rohrrahmentüren und Türschlössern mit 10er Nuß

- mit Rückholfeder
- mit verdeckt liegender Befestigung
- die eingebaute Rückholfeder sorgt immer für einen waagerechten Sitz
- Drückerstift □ 10 mm GRUPPE 3

Door handles for tubular frame doors and door locks with 10 mm spindle

- With return spring
- With concealed fixings
- The built-in return spring ensures the handle is always in a horizontal position.
- Spindle □ 10 mm GROUP 3

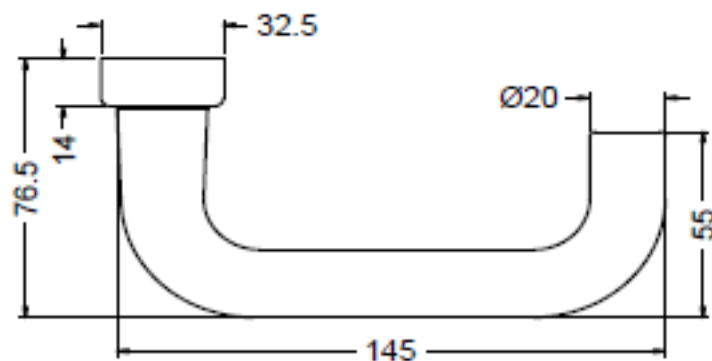

Material Material	Farbe Colour		Hinweis Note			Hinweis Note	
Alu	C0	210 678	-	10	218 893	-	10
Alu	RAL 9005	210 902	-	10	227 652	-	10
Alu	RAL 9010	210 680	-	10	218 895	-	10
Alu	RAL 9016	210 681	-	10	218 896	-	10
INOX	-	210 713	-	1	218 897	-	1

Drückerstift, Befestigungsplatte und Befestigungsschrauben gesondert bestellen.
Please order spindle, fixing plate and fixing screws separately.

Türdrücker Door handle

Türdrücker für Rohrrahmentüren und Türschlössern mit 10er Nuß

- mit Rückholfeder
- mit verdeckt liegender Befestigung
- die eingebaute Rückholfeder sorgt immer für einen waagerechten Sitz
- Drückerstift □ 10 mm GRUPPE 1

Door handles for tubular frame doors and door locks with 10 mm spindle

- With return spring
- With concealed fixings
- The built-in return spring ensures the handle is always in a horizontal position.
- Spindle □ 10 mm GROUP 1

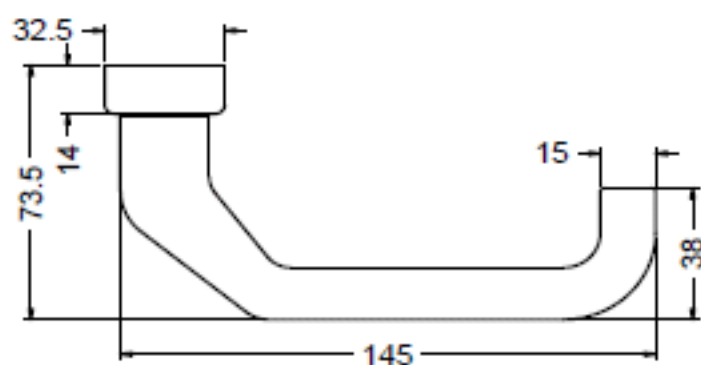

Material Material	Farbe Colour		Hinweis Note			Hinweis Note	
Alu	C0	210 709	-	10	218 893	-	10
Alu	RAL 9005	210 752	-	10	227 652	-	10
Alu	RAL 9010	210 711	-	10	218 895	-	10
Alu	RAL 9016	210 712	-	10	218 896	-	10
*INOX	-	*210 723	-	1	218 897	-	1

*Drückerstift □ 10 mm GRUPPE 2
*Spindle □ 10 mm GROUP 2

Drückerstift, Befestigungsplatte und Befestigungsschrauben gesondert bestellen.
Please order spindle, fixing plate and fixing screws separately.



Stangengriff für Fluchttürsysteme nach EN 1125 Push bar handle for emergency door systems in accordance with DIN EN 1125

Der Einsatzbereich dieser Stangengriffe sind hoch beanspruchte 1- und 2-flügelige Fluchttüren, wie z.B. in Krankenhäusern, Schulen, Kindergärten, Flughäfen, Gaststätten oder Einkaufszentren.

These push bar handles are used for single and double-leaf doors subject to heavy use, e.g. in hospitals, schools, kindergartens, airports, hotels or shopping centres.



Ausführung in Aluminium
Aluminium version



Ausführung in INOX
Stainless steel version

- mit integriertem Getriebe und Hochhaltefeder
- 9 mm Vierkant
- mit 1150 mm Griffrohr
- mit / ohne PZ-Lochung 92 mm
- incl. Befestigungsmaterial

- With integrated gearbox and return spring
- 9 mm key
- With 1150 mm hollow bar handle
- With/without profile cylinder recess 92 mm
- incl. Fixings

Fitting: • Inside: Push bar handle
• Outside: handle/door handle

Fitting: • Inside: Push bar handle
• Outside: handle/door handle

Material Material	Farbe Colour			
Alu	C0	240 192	240 194	1
INOX	-	240 193	240 195	1

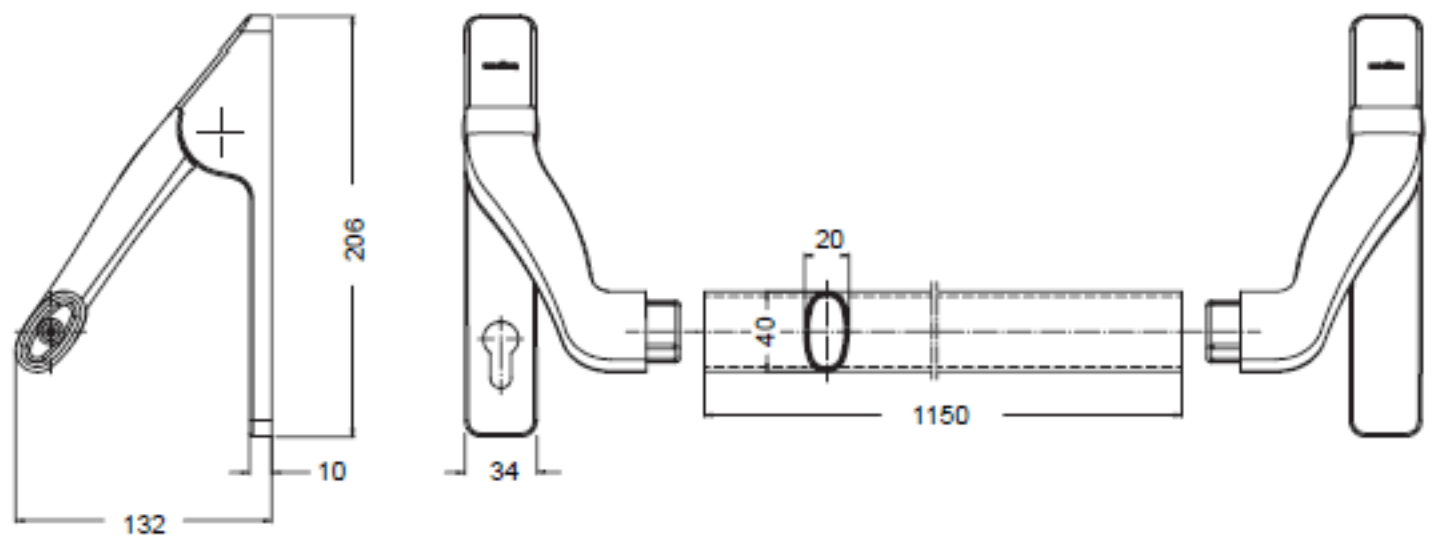

Druckstange für Fluchttürsysteme nach EN 1125 Push bar handle for emergency door systems in accordance with EN 1125

Der Einsatzbereich dieser Stangengriffe sind hoch beanspruchte 1- und 2-flügelige Fluchttüren, wie z.B. in Krankenhäusern, Schulen, Kindergärten, Flughäfen, Gaststätten oder Einkaufszentren.

These push bar handles are used for single and double-leaf doors subject to heavy use, e.g. in hospitals, schools, kindergartens, airports, hotels or shopping centres.



Achtung! Diese Druckstangen funktionieren nicht mit den SafeMatic-Schlössern.
Important: These push bar handles do not work with SafeMatic locks.







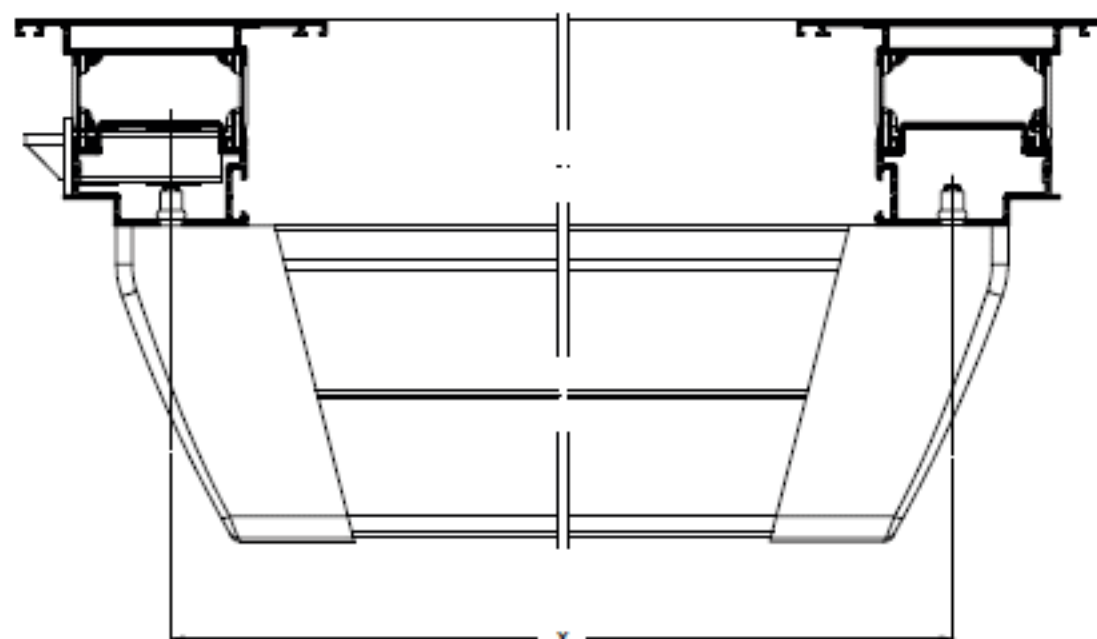























- mit integriertem Getriebe
- 9 mm Vierkant
- mit Griffrohr 758 - 1158 mm oder 1058 - 1458 mm
- ohne PZ-Lochung
- incl. Befestigungsmaterial.



















- With integrated gearbox
- 9 mm key
- With hollow bar handle of 758 - 1158 mm or 1058 - 1458 mm
- Not punched to accommodate profile cylinder
- incl. fixings.

Material Material	Farbe Colour	Maß „X“ 758-1158	Maß „X“ 1058-1458	Hinweis Note	
INOX	-	240 226	240 227	-	1
Alu	C0	240 224	240 225	-	1







Zuordnung von Drückerstiften bei Verwendung von beidseitigen Türdrückern Spindle table for lever handles on both sides





Serie Series	Konstruktion Construction	innen Inside		außen Outside		Gruppe 1 VE = 10	Gruppe 2 VE = 10	Gruppe 3 VE = 10
								
Schüco ADS 50.NI	flächenbündig Flush-fitted	 8 mm VE = 10	 9 mm VE = 1	 9 mm VE = 1	 9 mm VE = 1	227 871	208 015	227 873
Schüco ADS 50	flächenbündig Flush-fitted	 8 mm VE = 10	 9 mm VE = 1	 9 mm VE = 1	 9 mm VE = 1	227 871	208 015	227 873
Schüco ADS 60	flächenbündig Flush-fitted	 8 mm VE = 10	 9 mm VE = 1	 9 mm VE = 1	 9 mm VE = 1	208 015	227 872	218 805
Schüco ADS 65 Schüco ADS 65 RL	flächenbündig Flush-fitted	 8 mm VE = 10	 9 mm VE = 1	 9 mm VE = 1	 9 mm VE = 1	208 015	227 872	218 805
Schüco ADS 65 Schüco ADS 65 RL Schüco ADS 65 SL	aufschlagend Face-fitted	 8 mm VE = 10	-	-	-	227 872	218 804	227 874
Schüco ADS 70 RL.HI Schüco ADS 70.HI	flächenbündig Flush-fitted	 8 mm VE = 10	 9 mm VE = 1	 9 mm VE = 1	 9 mm VE = 1	227 872	218 804	227 874
Schüco ADS 70 RL.HI Schüco ADS 70 SL.HI Schüco ADS 70.HI	aufschlagend Face-fitted	 8 mm VE = 10	-	-	-	227 873	218 805	227 874
Schüco ADS 75 RL.SI Schüco ADS 75.SI	flächenbündig Flush-fitted	 8 mm VE = 10	 9 mm VE = 1	 9 mm VE = 1	 9 mm VE = 1	227 872	218 804	227 874
Schüco ADS 75 RL.SI Schüco ADS 75 SL.SI Schüco ADS 75.SI	aufschlagend Face-fitted	 8 mm VE = 10	-	-	-	218 804	227 873	227 874

Serie Series	Konstruktion Construction	innen Inside		außen Outside		Gruppe 1 VE = 10	Gruppe 2 VE = 10	Gruppe 3 VE = 10
								
Schüco ADS 65 HD	flächenbündig Flush-fitted	 8 mm VE = 10	 9 mm VE = 1	 9 mm VE = 1	 9 mm VE = 1	208 015	227 872	218 805
SchücoADS 65 HD.RL	aufschlagend Face-fitted	 8 mm VE = 10	-	-	-	227 872	218 804	227 873
SchücoADS 70 HD	flächenbündig Flush-fitted	 8 mm VE = 10	 9 mm VE = 1	 9 mm VE = 1	 9 mm VE = 1	227 872	218 804	227 874
Schüco ADS 70 HD.RL Schüco ADS 70 HD.SL	aufschlagend Face-fitted	 8 mm VE = 10	-	-	-	227 873	218 805	227 874
Schüco ADS 75 HD.HI	flächenbündig Flush-fitted	 8 mm VE = 10	 9 mm VE = 1	 9 mm VE = 1	 9 mm VE = 1	227 872	218 804	227 874
Schüco ADS 75 HD.RL.HI Schüco ADS 75 HD.SL.HI	aufschlagend Face-fitted	 8 mm VE = 10	-	-	-	218 804	227 873	227 874

Zuordnung von Drückerstiften bei Verwendung von einseitigen Türdrücker oder Stangengriff
Spindle table for using lever handle on one side or push-bar handle

 Door handle
Türdrücker

Serie Series	Konstruktion Construction	innen Inside		außen Outside		Gruppe 1 VE = 10	Gruppe 2 VE = 10	Gruppe 3 VE = 10
								
Schüco ADS 50.NI Schüco ADS 50 Schüco ADS 60 Schüco ADS 65 Schüco ADS 65 RL Schüco ADS 70 RL.HI Schüco ADS 70.HI Schüco ADS 75 RL.SI Schüco ADS 75.SI	flächenbündig Flush-fitted	□ 8 mm VE = 10	□ 9 mm VE = 1	□ 9 mm VE = 1	□ 9 mm VE = 1	207 222	229 691	208 014
Schüco ADS 65 Schüco ADS 65 RL Schüco ADS 65 SL Schüco ADS 70 RL.HI Schüco ADS 70 SL.HI Schüco ADS 70.HI Schüco ADS 75 RL.SI Schüco ADS 75 SL.SI Schüco ADS 75.SI	aufschlagend Face-fitted	208 850	-	-	-	229 691	209 789	227 870

Serie Series	Konstruktion Construction	innen Inside		außen Outside		Gruppe 1 VE = 10	Gruppe 2 VE = 10	Gruppe 3 VE = 10
								
Schüco ADS 65 HD Schüco ADS 70 HD Schüco ADS 75 HD.HI	flächenbündig Flush-fitted	□ 8 mm VE = 10	□ 9 mm VE = 1	□ 9 mm VE = 1	□ 9 mm VE = 1	207 222	229 691	208 014
Schüco ADS 65 HD.RL Schüco ADS 70 HD.RL Schüco ADS 70 HD.SL Schüco ADS 75 HD.RL.HI Schüco ADS 75 HD.SL.HI	aufschlagend Face-fitted	208 850	-	-	-	229 691	209 789	227 870



Befestigungsplatte

- Zur sicheren Türdrücker und Stoßgriffbefestigung
- Gewinde M 4 als Befestigungshilfe
- Gewinde M 5 Lochabstand 50 mm
- Gewinde M 8 Lochabstand 70 mm
- Befestigungsmaterial bitte gesondert bestellen

Fixing plate

- For fixing lever handles and bar handles securely.
- M 4 thread as fixing aid
- M 5 thread - 50 mm between holes
- M 8 thread - 70 mm between holes
- Order fixings separately

	Material Material		
-	INOX	229 128	10



Andruckstück

- Andruckstück als Einbauhilfe für die Befestigungsplatte 229 128,
- zum Einschieben in die äußere Profilkammer

Pressure pad

- Pressure pad as installation aid for the fixing plate 229 128 for insertion into the external profile chamber.

	Material Material		
-	KSINOX	218 297	10



Oval-Mutter

- zur nachträglichen Befestigung der Türdrücker geeignet.
- Gewinde M 5 Lochabstand 50 mm
- Die Ovalmutter wird durch die Türdrückeröffnung in das Profil eingeführt und durch das Montageband positioniert, fixiert.
- Die Befestigungsschrauben M 5 x 20 (mit Schraubensicherung) sind im Lieferumfang enthalten

Oval nut

- Suitable for retrofitting the door handles.
- M 5 thread - 50 mm between holes
- The oval nut is inserted into the profile through the door handle opening and positioned and fixed using the mounting tape.
- The fixing screws M5 x 20 (with screw locking) are included in the pack

			
-	-	227 860	10



Linsensenkschraube

- ISR nach ISO 10664-25
- zur Befestigung von Türdrückern

Oval head countersunk screw

- Torx-head as per ISO 10664-25
- For fixing lever handles

	Material Material		
M 5 x 20	INOX A4	205 320	100

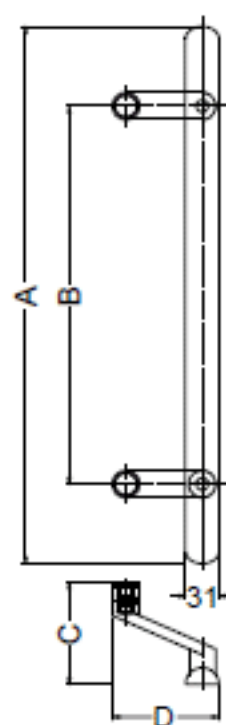

Türgriff, Schüco-Design Linie

- passend zu Türdrückern der Schüco-Design Linie
- DIN LS und DIN RS verwendbar
- 24° abgewinkelt
- Befestigungstyp A1

Door handle, Schüco Design line

- Suitable for Schüco Design line door handles
- For use DIN LH and RH
- Angled at 24°
- Fixing type A1

Farbe Colour	mm					Material Material	Hinweis Note	1
	A	B	C	D	Ø			
-	500	350	95	99		INOX	240 245	-

Die Befestigung entnehmen Sie bitte unter Berücksichtigung der Typangabe den entsprechenden Seiten dieser Stanzstufe!
For fixings, please refer to the relevant pages of this section, giving due consideration to the type details.

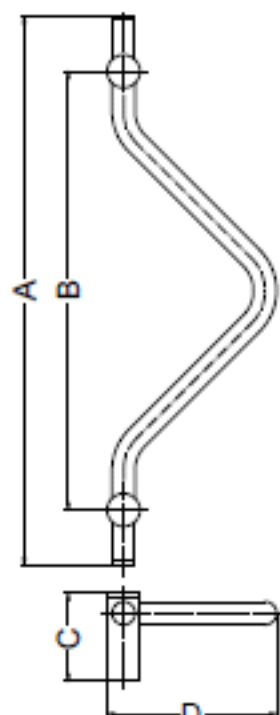

Türgriff als geschwungene Griffstange

- DIN LS und DIN RS verwendbar
- 90° abgewinkelt
- Befestigungstyp C2

Door pull as curved hand rail

- For use DIN LH and RH
- 90° fixed angle
- Fixing type C2

Farbe Colour	mm					Material Material	Hinweis Note	1
	A	B	C	D	Ø			
-	500	400	80	150	21	INOX	240 111	-

Die Befestigung entnehmen Sie bitte unter Berücksichtigung der Typangabe den entsprechenden Seiten dieser Stanzstufe!
For fixings, please refer to the relevant pages of this section, giving due consideration to the type details.

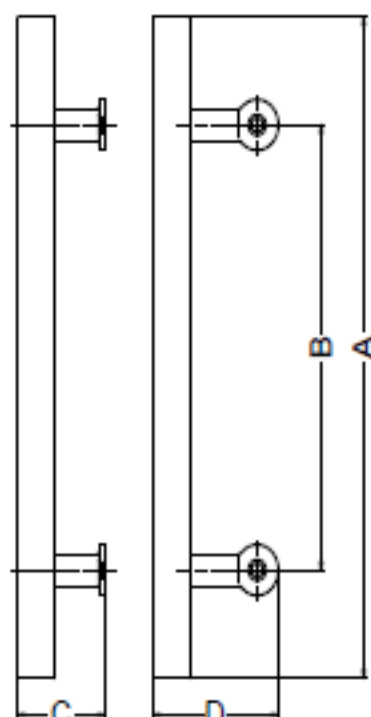

Türgriff gerade aus oval geformten Rohr

- DIN LS und DIN RS verwendbar
- Ø 40/28 mm
- 45° abgewinkelt
- Befestigungstyp B1

Straight door pull made from oval tubing

- For use DIN LH and RH
- Ø 40/28 mm
- Angled at 45°
- Fixing type B1

Farbe Colour	mm					Material Material	Hinweis Note	1
	A	B	C	D	Ø			
-	520	350	83	118		INOX	210 939	-

Die Befestigung entnehmen Sie bitte unter Berücksichtigung der Typangabe den entsprechenden Seiten dieser Stanzstufe!
For fixings, please refer to the relevant pages of this section, giving due consideration to the type details.

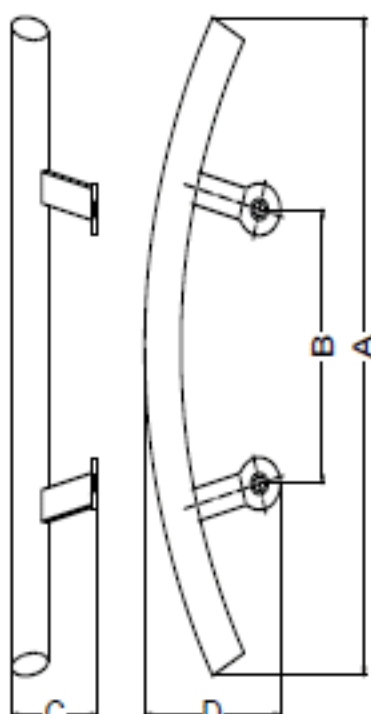

Türgriff gebogen aus oval geformten Rohr

- DIN LS und DIN RS verwendbar
- Ø 40/28 mm
- 45° abgewinkelt
- Befestigungstyp B1

Curved door pull made from oval tubing

- For use DIN LH and RH
- Ø 40/28 mm
- Angled at 45°
- Fixing type B1

Farbe Colour	mm					Material Material	Hinweis Note	1
	A	B	C	D	Ø			
-	504	210	83	130		INOX	210 938	-

Die Befestigung entnehmen Sie bitte unter Berücksichtigung der Typangabe den entsprechenden Seiten dieser Stanzstufe!
For fixings, please refer to the relevant pages of this section, giving due consideration to the type details.

Türgriffstange der Serie Oval für die Eigenfertigung Oval series door pulls for fabrication by customer

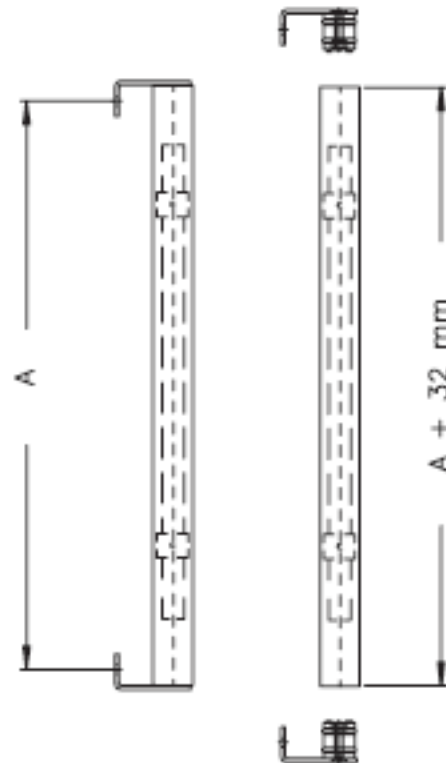

Einsatzbeispiele: abgewinkelt
Examples: angled

210 947 Türgriffstange Door handle

- Türgriffstange aus oval gefoimtem Rohr
- Ø 40/28 x 1,5 mm
- Lagerlänge 3 m
- Edelstahl A2
- zur Eigenfertigung
- Oval-shaped tubular door pull bar
- Ø 40/28 x 1.5 mm
- Stock length 3 m
- A2 stainless steel
- for customer fabrication

201 020 Stahlrohr Steel tube

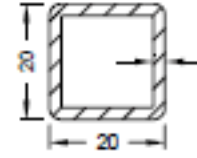

- Zur Verstärkung der Türgriffe
- verzinkte Ausführung
- Abmessungen: 20 x 20 x 2 mm
- Lagerlänge 6 m
- For strengthening door pulls
- galvanised finish
- Dimensions: 20 x 20 x 2 mm
- Stock length 6 m

237 273 Distanzhülse Spacer bush



- aus Kunststoff
- mit Fixierschraube
- zur Aufnahme des Stahlrohres in der Türgriffstange
- VE = 5 Stück
- Plastic
- with locating screw
- for incorporating the steel tube in the door pull bar
- PU = 5

Einsatz des Stahlrohrs und der Distanzhülse in Türgriffen an vielbe-
gangenen Türen oder bei denen das Maß A länger als 1500 mm ist.
The use of the steel tube and spacer bush for door pulls on heavily
used doors or doors for which dimension A exceeds 1500 mm.

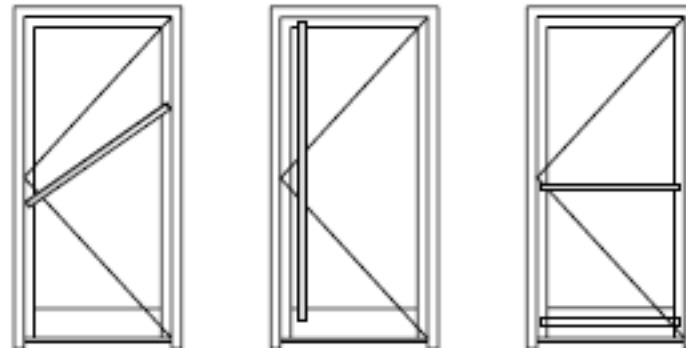

Einsatzbeispiele: gerade
Examples: straight

210 948 Halter gerade Straight bracket



- für Türgriffstange der Serie Oval
- aus Edelstahl A2
- VE = 1 Paar
- for Oval series door pulls
- A2 stainless steel
- PU = 1 pair

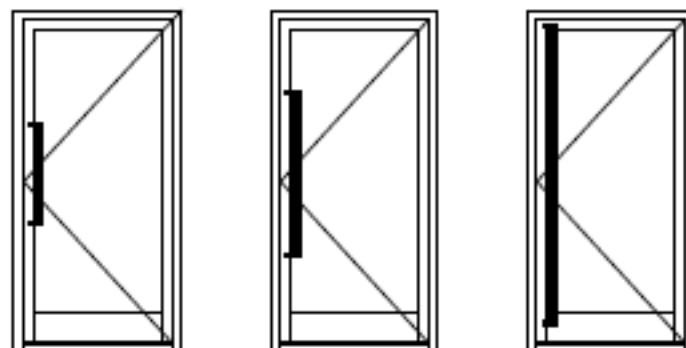

Einsatzbeispiele: gerade
Example: straight

210 949 Halter abgewinkelt (60°) Angled bracket (60°)

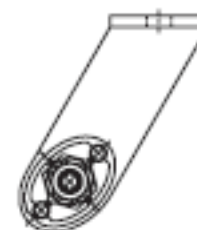

- für Türgriffstange der Serie Oval
- aus Edelstahl A2
- VE = 1 Paar
- for Oval series door pulls
- A2 stainless steel
- PU = 1 pair

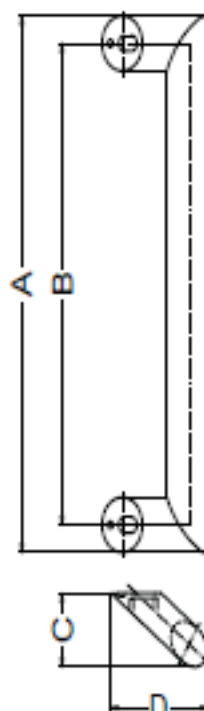

Türgriff eckig aus oval geformten Rohr

- DIN LS und DIN RS verwendbar
- Ø 40/28 mm
- 45° abgewinkelt
- Befestigungstyp B2

Curved door pull made from oval tubing

- For use DIN LH and RH
- Ø 40/28 mm
- Angled at 45°
- Fixing type B2

Farbe Colour	mm					Material Material	Hinweis Note		
	A	B	C	D	Ø				
-	390	350	85	105		INOX	210 940	-	1
-	390	350	85	105		INOX	210 941	②	1

② 1 Paar (innen und außen)
1 pair (inside and outside)

Die Befestigung entnehmen Sie bitte unter Berücksichtigung der Typangabe den entsprechenden Seiten dieser Stanzstufe!
For fixings, please refer to the relevant pages of this section, giving due consideration to the type details.

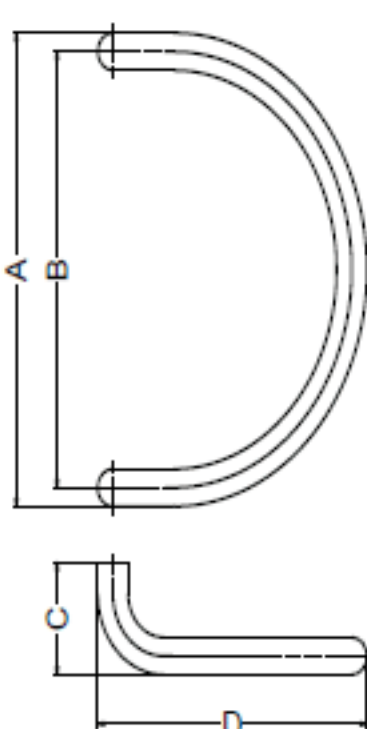

Türgriff, halbrund

- DIN LS und DIN RS verwendbar
- 90° abgewinkelt
- Befestigungstyp A1

Semi-circular door pull

- For use DIN LH and RH
- Angled at 90°
- Fixing type A1

Farbe Colour	mm					Material Material	Hinweis Note		
	A	B	C	D	Ø				
RAL 9016	334	300	85	239	34	PA	210 827	-	1
RAL 9005	334	300	85	239	34	PA	210 828	-	1
RAL 3003	334	300	85	239	34	PA	210 829	①	1
RAL 7038	334	300	85	239	34	PA	210 830	①	1
RAL 5003	334	300	85	239	34	PA	210 831	①	1

① über Sonderbestellung lieferbar
Available to special order

Die Befestigung entnehmen Sie bitte unter Berücksichtigung der Typangabe den entsprechenden Seiten dieser Stanzstufe!
For fixings, please refer to the relevant pages of this section, giving due consideration to the type details.

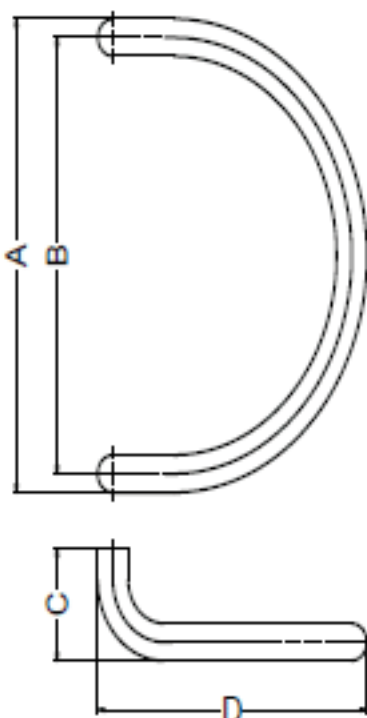

Türgriff, halbrund

- DIN LS und DIN RS verwendbar
- 90° abgewinkelt
- Befestigungstyp A1

Semi-circular door pull

- For use DIN LH and RH
- Angled at 90°
- Fixing type A1

Farbe Colour	mm					Material Material	Hinweis Note		
	A	B	C	D	Ø				
C0	380	350	90	265	30	Alu	210 754	-	1
RAL 9005	380	350	90	265	30	Alu	210 757	①	1
RAL 9010	380	350	90	265	30	Alu	210 755	-	1
RAL 9016	380	350	90	265	30	Alu	210 756	-	1
-	380	350	90	265	30	Messing	210 758	-	1
-	380	350	90	265	30	INOX	210 759	-	1
C0	225	200	78	165	25	Alu	210 760	-	1
RAL 9005	225	200	78	165	25	Alu	210 763	①	1
RAL 9010	225	200	78	165	25	Alu	210 761	①	1
RAL 9016	225	200	78	165	25	Alu	210 762	①	1
-	225	200	78	165	25	Messing	210 764	-	1
-	225	200	78	165	25	INOX	210 765	①	1

① über Sonderbestellung lieferbar
Available to special order

Die Befestigung entnehmen Sie bitte unter Berücksichtigung der Typangabe den entsprechenden Seiten dieser Stanzstufe!
For fixings, please refer to the relevant pages of this section, giving due consideration to the type details.

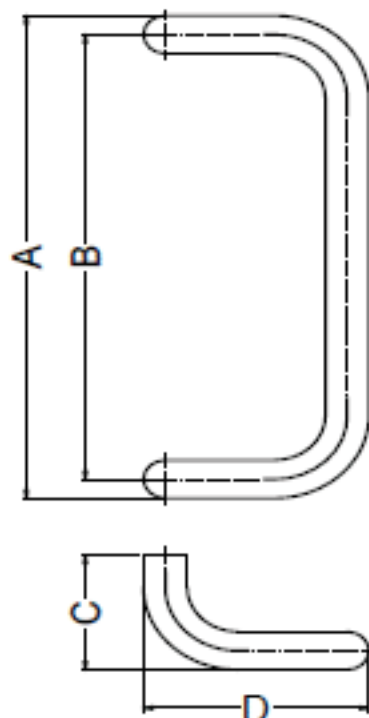

Türgriff, rechteckig

Rectangular door pull

- DIN LS und DIN RS verwendbar
- 90° abgewinkelt
- Befestigungstyp A1

- For use DIN LH and RH
- Angled at 90°
- Fixing type A1

Farbe Colour	mm					Material Material	Hinweis Note		
	A	B	C	D	Ø				
RAL 9016	334	300	85	120	34	PA	210 839	-	1
RAL 9005	334	300	85	120	34	PA	210 840	-	1
RAL 3003	334	300	85	120	34	PA	210 841	①	1
RAL 7038	334	300	85	120	34	PA	210 842	①	1
RAL 5003	334	300	85	120	34	PA	210 843	①	1
RAL 8019	334	300	85	120	34	PA	210 844	①	1
RAL 9016	234	200	85	120	34	PA	210 833	-	1
RAL 9005	234	200	85	120	34	PA	210 834	①	1
RAL 3003	234	200	85	120	34	PA	210 835	①	1
RAL 7038	234	200	85	120	34	PA	210 836	①	1
RAL 5003	234	200	85	120	34	PA	210 837	①	1
RAL 8019	234	200	85	120	34	PA	210 838	①	1

- ① über Sonderbestellung lieferbar
Available to special order

Die Befestigung entnehmen Sie bitte unter Berücksichtigung der Typangabe den entsprechenden Seiten dieser Stanzstufe!
For fixings, please refer to the relevant pages of this section, giving due consideration to the type details.

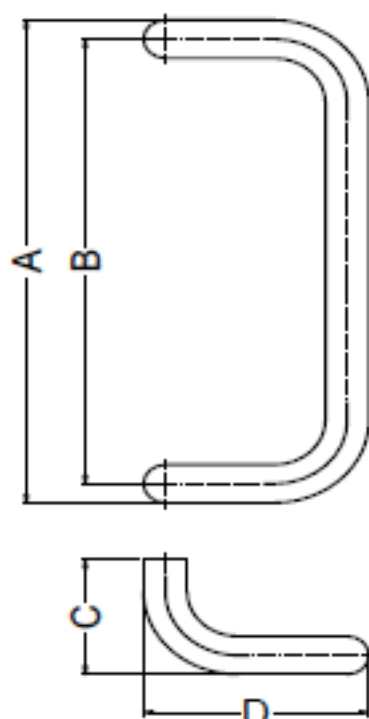

Türgriff, rechteckig

Rectangular door pull

- DIN LS und DIN RS verwendbar
- 90° abgewinkelt
- Befestigungstyp A1

- For use DIN LH and RH
- Angled at 90°
- Fixing type A1

Farbe Colour	mm					Material Material	Hinweis Note		
	A	B	C	D	Ø				
C0	380	350	90	155	30	Alu	210 790	-	1
RAL 9005	380	350	90	155	30	Alu	210 793	-	1
RAL 9016	380	350	90	155	30	Alu	210 792	-	1
-	380	350	90	155	30	Messing	210 794	-	1
-	380	350	90	155	30	INOX	210 795	-	1
C0	375	350	78	113	25	Alu	210 808	-	1
RAL 9016	375	350	78	113	25	Alu	210 810	-	1
-	375	350	78	113	25	INOX	210 813	-	1
C0	330	300	90	155	30	Alu	210 796	-	1
RAL 9005	330	300	90	155	30	Alu	210 799	①	1
RAL 9016	330	300	90	155	30	Alu	210 798	-	1
-	330	300	90	155	30	INOX	210 801	-	1
C0	325	300	78	113	25	Alu	210 802	-	1
RAL 9005	325	300	78	113	25	Alu	210 805	①	1
RAL 9016	325	300	78	113	25	Alu	210 804	-	1
-	325	300	78	113	25	INOX	210 807	①	1

- ① über Sonderbestellung lieferbar
Available to special order

Die Befestigung entnehmen Sie bitte unter Berücksichtigung der Typangabe den entsprechenden Seiten dieser Stanzstufe!
For fixings, please refer to the relevant pages of this section, giving due consideration to the type details.

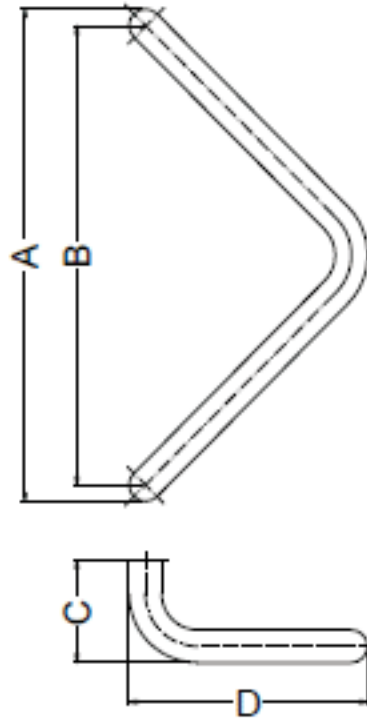

Türgriff, dreieckig

- DIN LS und DIN RS verwendbar
- 90° abgewinkelt
- Befestigungstyp A1

Triangular door pull

- For use DIN LH and RH
- Angled at 90°
- Fixing type A1

Farbe Colour	mm					Material Material	Hinweis Note		
	A	B	C	D	∅				
RAL 9016	334	300	85	167	34	PA	210 845	-	1
RAL 9005	334	300	85	167	34	PA	210 846	-	1
RAL 3003	334	300	85	167	34	PA	210 847	①	1
RAL 7038	334	300	85	167	34	PA	210 848	①	1
RAL 5003	334	300	85	167	34	PA	210 849	①	1
RAL 8019	334	300	85	167	34	PA	210 850	①	1

① über Sonderbestellung lieferbar
Available to special order

Die Befestigung entnehmen Sie bitte unter Berücksichtigung der Typangabe den entsprechenden Seiten dieser Stanzstufe!
For fixings, please refer to the relevant pages of this section, giving due consideration to the type details.

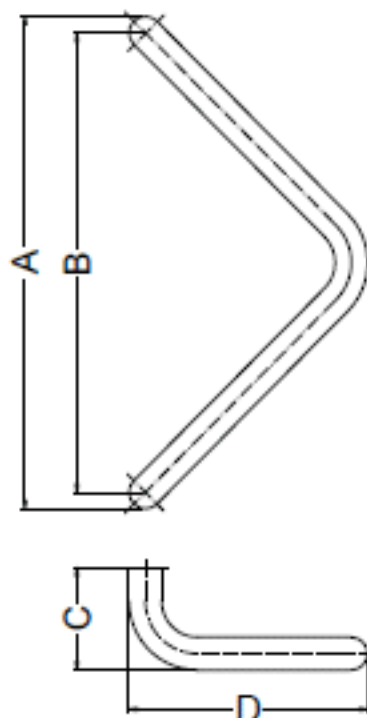

Türgriff, dreieckig

- DIN LS und DIN RS verwendbar
- 90° abgewinkelt
- Befestigungstyp A1

Triangular door pull

- For use DIN LH and RH
- Angled at 90°
- Fixing type A1

Farbe Colour	mm					Material Material	Hinweis Note		
	A	B	C	D	∅				
C0	375	350	78	183	25	Alu	210 766	①	1
RAL 9005	375	350	78	183	25	Alu	210 769	①	1
RAL 9010	375	350	78	183	25	Alu	210 767	①	1
RAL 9016	375	350	78	183	25	Alu	210 768	①	1
-	375	350	78	183	25	INOX	210 771	-	1
C0	380	350	90	184	30	Alu	210 778	-	1
RAL 9005	380	350	90	184	30	Alu	210 781	-	1
RAL 9010	380	350	90	184	30	Alu	210 779	-	1
RAL 9016	380	350	90	184	30	Alu	210 780	-	1
-	380	350	90	184	30	INOX	210 783	-	1
C0	325	300	78	158	25	Alu	210 772	-	1
RAL 9005	325	300	78	158	25	Alu	210 775	①	1
RAL 9010	325	300	78	158	25	Alu	210 773	①	1
RAL 9016	325	300	78	158	25	Alu	210 774	①	1
-	325	300	78	158	25	INOX	210 777	-	1
C0	330	300	90	159	30	Alu	210 784	-	1
RAL 9005	330	300	90	159	30	Alu	210 787	①	1
RAL 9010	330	300	90	159	30	Alu	210 785	①	1
-	330	300	90	159	30	INOX	210 789	-	1

① über Sonderbestellung lieferbar
Available to special order

Die Befestigung entnehmen Sie bitte unter Berücksichtigung der Typangabe den entsprechenden Seiten dieser Stanzstufe!
For fixings, please refer to the relevant pages of this section, giving due consideration to the type details.

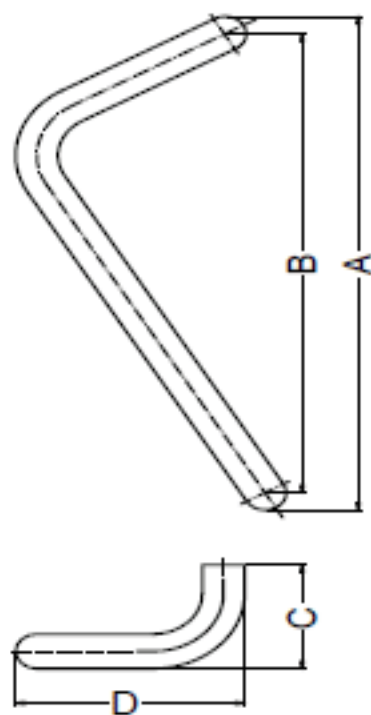

Türgriff, dreieckig

- für DIN LS Türen
- Bitte „nach außen“ bzw. „nach innen“ öffnend beachten!
- 90° abgewinkelt
- Befestigungstyp A1

Triangular door pull

- For DIN LH doors
- Please note whether „outward-opening“ or „inward-opening“
- Angled at 90°
- Fixing type A1

Farbe Colour	mm					Material Material		Hinweis Note	📄
	A	B	C	D	Ø				
C0	430	400	90	192	30	Alu	210 815	-	1
RAL 9005	430	400	90	192	30	Alu	210 821	❶	1
-	430	400	90	192	30	INOX	210 825	-	1

- ❶ über Sonderbestellung lieferbar
Available to special order

Die Befestigung entnehmen Sie bitte unter Berücksichtigung der Typangabe den entsprechenden Seiten dieser Stanzstufe!
For fixings, please refer to the relevant pages of this section, giving due consideration to the type details.

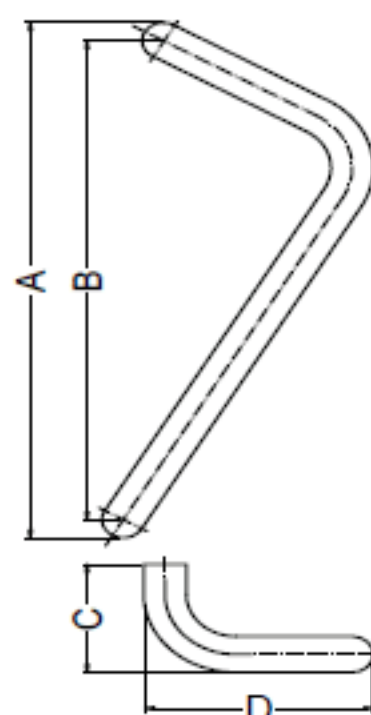

Türgriff, dreieckig

- für DIN RS Türen
- Bitte „nach außen“ bzw. „nach innen“ öffnend beachten!
- 90° abgewinkelt
- Befestigungstyp A1

Triangular door pull

- For DIN RH doors
- Please note whether „outward-opening“ or „inward-opening“
- Angled at 90°
- Fixing type A1

Farbe Colour	mm					Material Material		Hinweis Note	📄
	A	B	C	D	Ø				
C0	430	400	90	192	30	Alu	210 816	-	1
RAL 9005	430	400	90	192	30	Alu	210 822	❶	1
-	430	400	90	192	30	INOX	210 826	-	1

- ❶ über Sonderbestellung lieferbar
Available to special order

Die Befestigung entnehmen Sie bitte unter Berücksichtigung der Typangabe den entsprechenden Seiten dieser Stanzstufe!
For fixings, please refer to the relevant pages of this section, giving due consideration to the type details.